

ArcelorMittal Europe - Long Products  
Sections and Merchant Bars



ArcelorMittal

# High-rise buildings



© TomRossierPhotography





Electric arc furnace



Rolling process

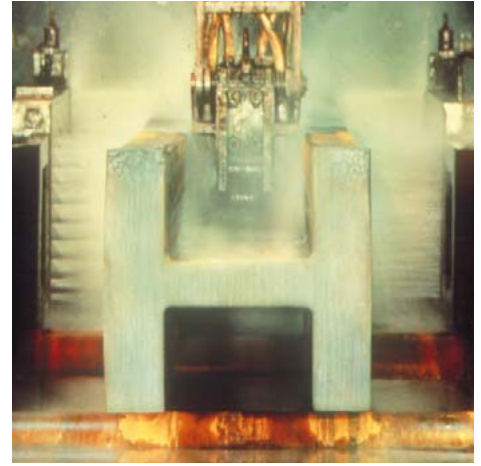

Quenching and Self-Tempering (QST) process for HISTAR® steel



Shanghai World Financial Center, Shanghai, China

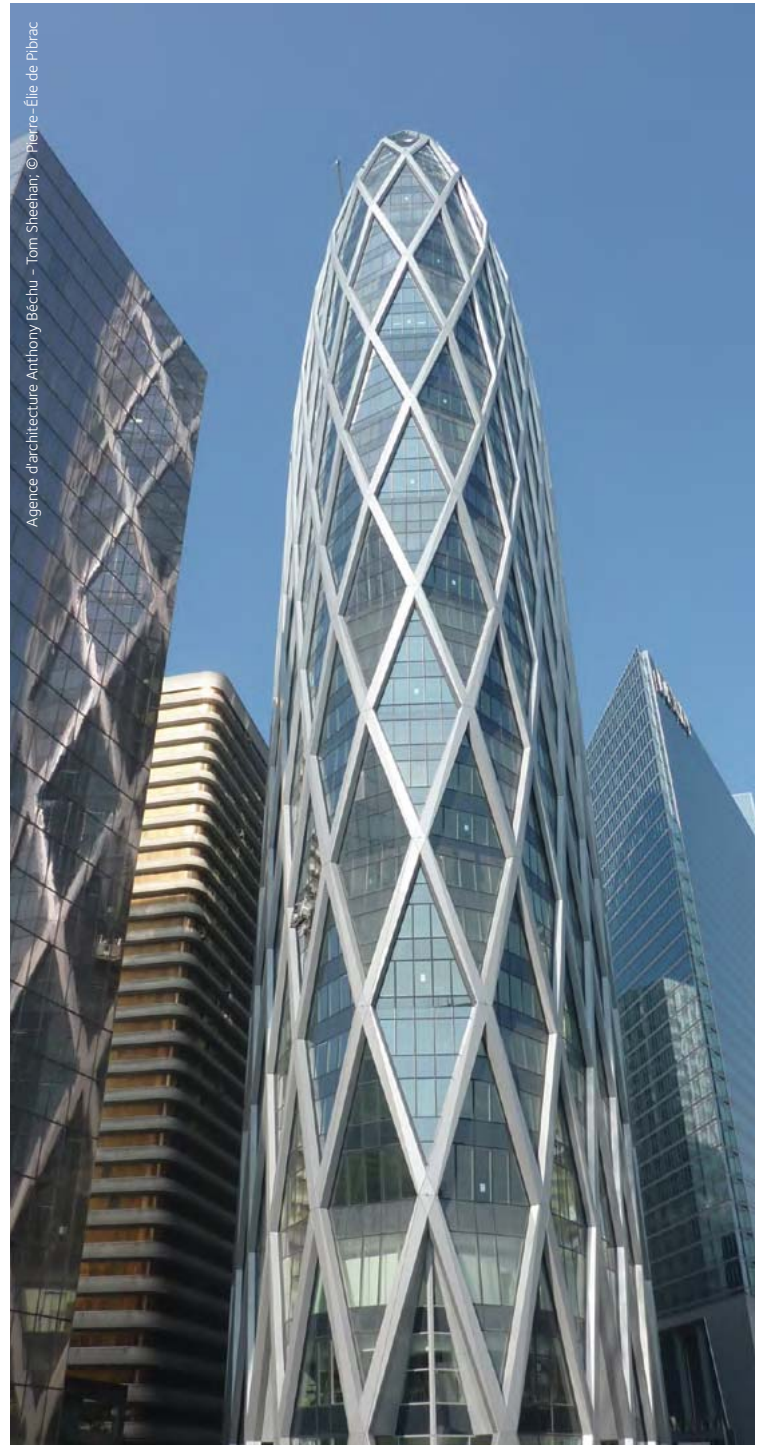

D2 Tower, Paris, France

Dear Reader,

We are delighted to present to you the high-rise buildings brochure. It features suggestions and advice about the optimal use of hot-rolled shapes in tall buildings.

We offer the widest range of structural shape sizes & steel grades and here, you will find a comprehensive information about their properties as well as their advantages and applications in high-rise buildings.

Since we operate a policy of continuous product development, this brochure will be subject to changes. In order to remain up-to-date with our latest developments, we invite you to regularly consult our website: [sections.arcelormittal.com](http://sections.arcelormittal.com).

In addition to this brochure, our commercial teams and technical advisory are at your disposal to answer any question you may have: [sections.sales@arcelormittal.com](mailto:sections.sales@arcelormittal.com).

Kind regards,

A handwritten signature in black ink, appearing to read 'Tapas Rajderkar', with a stylized flourish at the end.

Tapas Rajderkar

ArcelorMittal Europe - Long Products  
CEO Sections and Merchant Bars

Dear Reader,

This ArcelorMittal publication, focusing on high-rise buildings, was produced with the assistance and guidance of the Council on Tall Buildings and Urban Habitat (CTBUH), the world's leading resource for professionals focused on the inception, design, construction and operation of tall buildings and future cities. The Council's research department is spearheading the investigation of the next generation of tall buildings by aiding original research on sustainability and key development issues. Part of this research includes examining the optimal structural solutions for tall buildings.

This ArcelorMittal publication highlights how structural steel can be used in tall buildings and directly references the Outrigger Design for High-Rise Buildings and Recommendations for Seismic Design Technical Guides developed by CTBUH Working Groups. The Life Cycle Assessment of Tall Building Structural Systems and Composite Megacolumns Research Reports, which were made possible through research grants provided by ArcelorMittal, are also discussed in this publication.

Furthermore, CTBUH hosts the world's premier free database on tall buildings, The Skyscraper Center ([skyscrapercenter.com](http://skyscrapercenter.com)), which is updated daily with detailed information, images, data and news. This database houses information on more than 25 000 buildings, with ArcelorMittal providing steel services for over 150 of the buildings featured on this site.

We hope this publication provides you with useful information on the application of steel in tall structures.

Sincerely,

A handwritten signature in black ink that reads "Antony Wood". The signature is written in a cursive, slightly slanted style.

Antony Wood

CTBUH Executive Director







# Table of contents



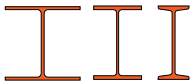

1. About ArcelorMittal.....	07
2. Advantages of steel.....	08
3. HISTAR® grades for high-rise buildings.....	10
4. Columns.....	13
5. Bracing systems.....	29
6. Beams and floor systems.....	35
7. Connections.....	43
8. Foundations for high loads.....	49
9. Fire resistance.....	51
10. Robustness.....	53
11. Earthquake design.....	54
12. Sustainability of Steel.....	58
13. Reference projects.....	62
14. ArcelorMittal services.....	78



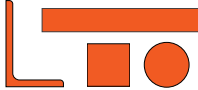



The term "high-rise building" refers in this brochure to buildings with a minimum height (height understood as height to tip) of about 150m including super tall buildings (300 metres high) and mega tall buildings (600 metres high). The number of floors is understood as the number of floors above ground.







Brochure values expression: decimal separator: comma; thousands separator: thin space.



Photography: ArcelorMittal Library; Non-contractual document - All rights reserved for all countries. cannot be disclosed, used or reproduced without prior written specific authorisation of ArcelorMittal. Copyright 2019 ArcelorMittal.

Sections and Merchant Bars				
Sections				Merchant Bars
Beams	Columns	Bearing Piles	Channels	Web Tailor-Made Shapes
				
<ul style="list-style-type: none"> <li>HE 100 - 1000</li> <li>HL 920 - 1100 / HLZ</li> <li>IPE 80 - 750</li> <li>UB 127 x 76 - 1100 x 400</li> <li>W 6 x 4 - 44 x 16</li> <li>GOST 10B1 - 50B3</li> <li>IPN 80 - 600</li> <li>J 76 - 152</li> <li>S 3 - 24</li> </ul>	<ul style="list-style-type: none"> <li>HD 260 - 400</li> <li>UC 152 x 152 - 356 x 406</li> <li>W 4 x 4 .. 14 x 16</li> <li>GOST 20K1 - 40K5</li> </ul>	<ul style="list-style-type: none"> <li>HP 200 - 400</li> <li>UBP 203 x 203-356 x 368</li> <li>HP 8 - 14</li> </ul>	<ul style="list-style-type: none"> <li>UPE 80 - 400</li> <li>PFC 100 - 430</li> <li>UPN 50 - 400</li> <li>C 8 - 12</li> <li>MC 6 - 18</li> <li>GOST 8Y - 30Y</li> </ul>	<ul style="list-style-type: none"> <li>L 45 x 45 - 300 x 300</li> <li>L 100 x 65 - 250 x 90</li> <li>L 2 - 12</li> <li>SQ 90 x 90 - 160 x 160</li> <li>R 90 - 150</li> <li>HTM 610 - 1016</li> <li>WTM 24 - 40</li> </ul>

Sheet Piles			
AZ®-Section	U-Section	Combi-wall HZ®-M/AZ®	Flat Sheet Pile AS 500®
			
AZ 18 - 800 - AZ 27 - 800 AZ 28 - 750 - AZ 32 - 750 AZ 12-770 - AZ 52-700 AZ 18 - AZ 50	AU™ 14 - AU™ 25 PU 12 - PU 32 GU 6N - GU 33N	HZ 680M LT - HZ 880M A - C HZ 1080M A - D - HZ 1180M A - D	AS 500 9.5-13 I.S. max = 6000 kN/m

Rails						
Transport Rails and Rails for Crossovers			Crane & Light rail			
Vignole Type	Grooved & Block Type GI	Rails for Crossovers	Crane rails	Girder Crane rails	Conductors	Light Rails
						
EN 13674-1, EN 13674-2, AS 1085. 1, GOST P51685, ASCE, IRS, ArcelorMittal Specifications, AREMA	EN 14811, 2006 +A1, ArcelorMittal Specifications	EN 13674-3	DIN 536, ASTM, MRS, AS, CR, CRS, JKL, SP, RG, ArcelorMittal Specifications	GCRD42, GCRD45, GCRD108, GCRD183	STR40, STR74, ArcelorMittal Specifications	DIN 5901, DIN 17100, EN 13674-4, DIN 20501, PN-79/H, ASTM, BS11, ZN 2004

Special Sections					
Cathode bars	Track Shoes	Mining		Other special sections	
		Mining sections	Mining Accessories	Rail Accessories	Flanges
					
Square Rectangular	Single grouser Double grousers Triple grousers	TH40 - TH44 V25 - V36	GTHN 29 J21 - J36 A36 CLAMP E74VS	Ribbed baseplates, Tie plates standard, Tie plates Type Pandrol, Guiding bar for Metro Cross hearts Fishplates	Rectangular L shape T shape

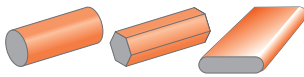
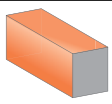
Bars and Rods			
Rebars	Wire Rod	SBQ	Semis
			
Bars : ø 8 - 40 mm Coils : ø 6 - 25 mm	Round : ø 5 - 52 mm Hexagon : ø 14,3 - 42,5 mm  Mesh, Low and High carbon steels, Cold heading, Welding, Free-cutting, Spring, Steel cord, Bearing	Round : ø 15 - 170 mm Hexagon : ø 14,3 - 70,4 mm Round corner square : □ 63 - 200 mm <sup>2</sup>	Round billets: ø 180 - 310 mm Square billets: □ 120 <sup>2</sup> - 320 <sup>2</sup> mm Rectangular billets: □ 155 x 270 190 x 220; 240 x 270; 265 x 385; 280 x 300; 280 x 310; 280 x 400

Sections & Merchant Bars: [sections.arcelormittal.com](http://sections.arcelormittal.com)

Rebars, Mesh & Pre-Stressed concrete: [barsandrods.arcelormittal.com](http://barsandrods.arcelormittal.com)

Steel Decks: [ds.arcelormittal.com/construction](http://ds.arcelormittal.com/construction)

Facades & Claddings: [industry.arcelormittal.com/steelenvlope](http://industry.arcelormittal.com/steelenvlope)

Partitions: [ds.arcelormittal.com/construction](http://ds.arcelormittal.com/construction)

Sheet piles and Bearing piles: [sheetpiling.arcelormittal.com](http://sheetpiling.arcelormittal.com)

All products for construction: [constructalia.arcelormittal.com](http://constructalia.arcelormittal.com)

The intelligent construction choice: [stelignce.arcelormittal.com](http://stelignce.arcelormittal.com)

Visit us on:



# 1. About ArcelorMittal

## ArcelorMittal

ArcelorMittal is the world's leading steel and mining company, with a presence in 60 countries and an industrial footprint in 18 countries. ArcelorMittal is the leader in all major global steel markets, including automotive, construction, household appliances and packaging, with leading R&D and technology, as well as sizeable captive supplies of raw materials and outstanding distribution networks. An industrial presence on four continents exposes the company to all major markets, from emerging to developed. We are the largest producer of steel in the EU, North & South America and Africa, a significant steel producer in the CIS region, and have a growing presence in Asia, including investments in China and India.

## ArcelorMittal Europe – Long Products

Long Products operates at 29 production sites in 10 countries. Long products include sections, merchant bars, wire rod,

special quality bars, rebar, rails, sheet piles, special sections, billets, and blooms.

ArcelorMittal Europe – Long Products is a leader in sections, sheet piles, rails and quality wire rod. It offers the widest range from small sections to jumbo beams according to many standards and covering the full range of applications.



**Electric arc furnace, Luxembourg**

We are the largest recycler of steel in the world notably thanks to the electric arc furnace technology. ArcelorMittal's facilities of Differdange can provide sections with unique dimensions in the world, including finishing from Steligence® Fabrication Centre if requested.

### Technical support

ArcelorMittal provides free technical advice to assist designers in using its unique products and materials to their full potential. The technical advisory team is available to answer questions about structural shapes, merchant bars, design of structural elements, construction details, surface protection, fire safety and welding.

The team of technical specialists is readily available to support projects throughout the world.

ArcelorMittal also offers free software and technical documents to support designers. These tools can be downloaded at: [sections.arcelormittal.com](https://sections.arcelormittal.com) or upon request at [sections.sales@arcelormittal.com](mailto:sections.sales@arcelormittal.com)



**ArcelorMittal office building (AOB), Esch-sur-Alzette, Luxembourg**

"The competition for material selection between steel, concrete, timber and other materials is as fierce as ever. Key criteria in the choice of material include element size, fire rating / the need for supplementary material, sustainability, vibration characteristics, availability, shape opportunity, as well as cost, including predictability of costs. We have found that the innovations brought to market by ArcelorMittal and steel's inherent characteristics enable the material to remain competitive and most often the material of choice. In particular, the increase in available strength and reduction in preheat requirements developed by ArcelorMittal and embodied in the A913 / HISTAR® specifications has made the selection of steel an even easier decision."

**Barry Charnish, P.Eng.**

Principal

**ENTUITIVE**

Toronto, Canada

## 2. Advantages of steel

The main advantages of steel are:

- **stiffness, ductility and resistance**
- **prefabrication and speed of construction**
- **flexibility**
- **sustainability (reusability & indefinitely recyclable)**
- **reliability**



**Figure 2.1: Tour D2, half of the weight is carried by exterior steel diagrid, Courbevoie, France**

- increased usable "carpet" area (the footprint of a column is approximately 10 times smaller in steel than in concrete)
- lighter columns (about 3 to 6 times lighter than concrete columns)
- lower loads transferred to foundations (total building weight is more than 2 times lighter in steel than in concrete)
- long span

### Example: Comparison between concrete and steel columns

Load = 15000kN (≈ 25 floors), Buckling length = 4m

Class / Grade	Concrete C60	HISTAR® 460
Dimensions / Section	650 x 650mm	HD 400 x 314
Weight	1060kg/m	314kg/m
Column area	0,42m <sup>2</sup>	0,04m <sup>2</sup>

### • Stiffness & resistance

Steel is the most efficient material for columns thanks to its stiffness and resistance. Steel solutions are 5 to 8 times stiffer and about 10 times more resistant than concrete.

Steel has a very high strength to weight ratio, leading to :

- minimum construction dimensions

It is widely acknowledged that steel structures inherently offer superior performance in earthquakes compared to masonry or reinforced concrete.



**Figure 2.2: Broad J57 Tower, 19 days for 57 storeys, Changsha, China**

### • Fabrication and speed

Fabrication of steel elements is carried out in a workshop, leading to:

- less material and waste on-site
- minimum disruptions to the surroundings (e.g. less noise)
- ease of construction
- reduced workforce on-site
- higher level of safety for the workers
- reduced management costs on-site
- optimised construction time
- earlier pay-back of investments



Dimensions in mm

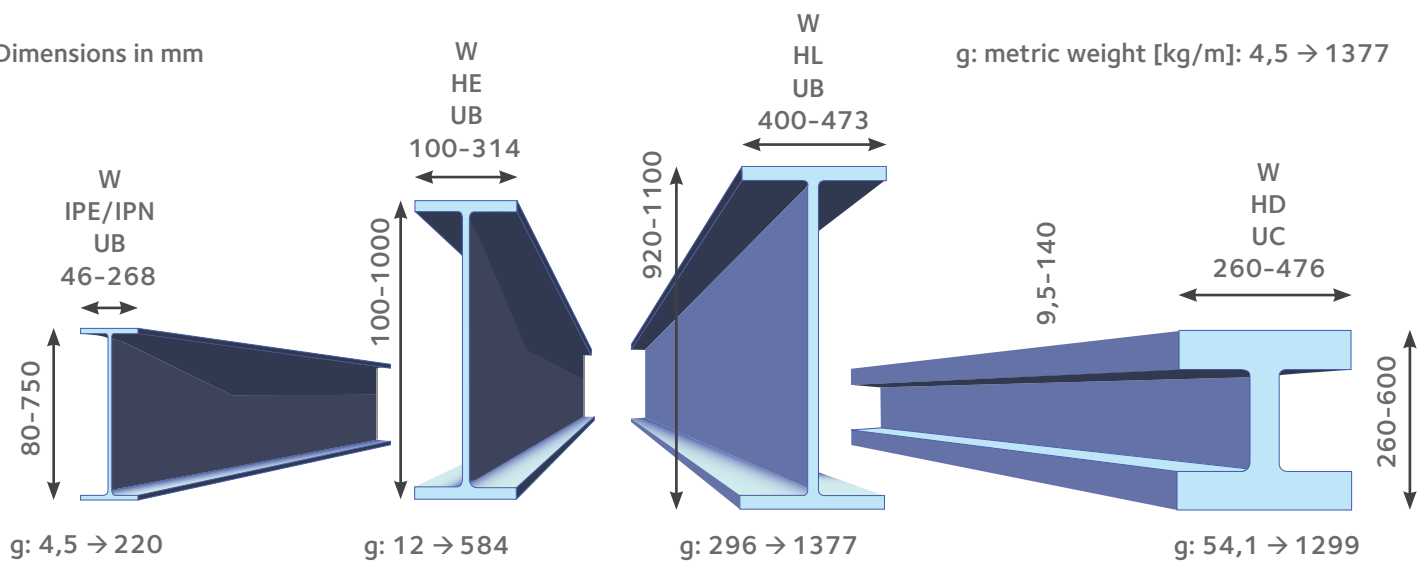

**ArcelorMittal offers the widest range of beams – also available with fabrication**

### • Flexibility

Structural steel can be combined with other materials to achieve the desired look, properties or functionalities. Steel is the material “par excellence” when it comes to inventing new structures and forms. All solutions are possible, from the very simplest to the most challenging ones. No other material is used to make structures which are so slender, light and transparent. Forms can be created using different structural effects and envelopes with pure or finely sculpted curves.



© Marshall Gerometta / CTBUH

**Figure 2.3: Emirates Tower One, Dubai, UAE**

Steel provides the flexibility needed to enable a building to evolve throughout its working life. The building can be initially designed in order to facilitate future evolutions:

- modification of applied loads due to change of the building's usage
- floor plan layout
- possibility to create new openings in façade or slab.

### • Sustainability

It is ArcelorMittal's corporate approach to produce safe and sustainable steel reflecting our commitment to protect and improve the environment in which we live and work. We constantly work to develop clean practices in steel production. More than 1 500 research engineers are constantly trying to develop cleaner and greener processes to produce steel.

One example is the development of the modern high strength steel HISTAR®. By increasing the strength of the steel, less material is needed. For example, HISTAR® which has been used in buildings such as One World Trade Center in New York and Emirates Tower One in Dubai, can reduce CO<sub>2</sub> emissions during construction phase by as much as 30%.

Steel is an especially sustainable material as it can indefinitely be recycled, without quality loss. Thanks to this property, it surpasses other materials and saves millions of tonnes of resources worldwide.



**Figure 2.4: Scrap yard, Belval, Luxembourg**

### • Reliability

All structural steel products made by ArcelorMittal are manufactured using automated and computerised industrial processes. Finished products are subjected to high levels of quality controls to ensure the best finished quality.



Figure 3.1 HISTAR® in Shanghai World Financial Center

## 3. HISTAR® grades for high-rise buildings

### • Conventional steel

ArcelorMittal manufactures I-sections, H-sections, channels, steel angles and bars. The product range includes all dimensions for European standards, and many dimensions from the American and Russian standards. Upon request, sections can also be produced according to custom dimensions and geometries.

Rolled sections are delivered in grades complying with European, American, Russian and Chinese standards. Other grades (e.g. Canadian CSA standards) can be supplied upon request. In Europe, ArcelorMittal offers conventional S235, S355, S460 and S500 steel (see table below). S355 is becoming the base grade for all kinds of applications for steel. S500 is feasible and will be available as soon as it will be included in the EN product standard.

### • HISTAR®/ASTM A913 & products standards

In addition to conventional steel, ArcelorMittal offers HISTAR® 355 & 460, HISTAR®/ASTM A913 Grade 50, Grade 65, Grade 70 steels and grade, which exceed standard requirements. HISTAR® steels are advanced thermo-mechanical structural steels that are manufactured with the in-line QST (Quenching and Self-Tempering) process.

They are low-alloyed, high-strength thermo-mechanical fine grained structured steels with excellent weldability and good toughness values.

An outstanding feature of these high strength steels is their low-carbon equivalent, allowing easier processing for fabricators. As such, preheating before welding can usually be avoided and lead to substantial time and cost savings. HISTAR® grade steel products are available for multiple European, British and American dimensions standards (see table on the following page).



Figure 3.2: HISTAR® advantages

### Product standards for steel grades

Class / Grade		Europe		USA			China
Yield Strength [MPa]	HISTAR®	EN10025 - 2	EN10025 - 4	ASTM A913	ASTM A992	ASTM A572	GB/T 33968-2017
355	355	S355 J0/JR/J2/K2	S355M/ML	Grade 50	Grade 50	Grade 50	Q345QST
460	460	S450J0/JR/J2/K2	S460M/ML	Grade 65		Grade 60	Q460QST
500		S500 J0/J2	S500M/ML	Grade 70			Q485QST
550				Grade 80*			

\*Sept. 2019: expected in A913



## Dimensions standards for HISTAR® grades

Class / Grade	European Standards	British Standards	American Standards
Parallel flange beams	IPE 550*, IPE 600 - IPE 750	UB 610 x 229 - UB 838 x 292	W 24 - W 36
Wide flange beams	HE 260* - HE 280*, HE 300 - HE 1000		
Extra wide flange beams	HL 920 - HL 1100	UB 914 x 305 - UB 1016 x 305	W 36 - W 44
Wide flange columns	HD 260 - HD 400	UC 152 x 152 - UC 356 x 406	W 10 - W 14
Wide flange bearing piles	HP 200 - HP 400	UBP 203 x 203 - UBP 356 x 368	HP 10 - HP 14

\*on request

### — Benefits of HISTAR®

The yield strengths of HISTAR® grades are superior across the entire range of material thickness compared to standard structural steels (Table 3.3). Engineers around the world are taking advantage of HISTAR® steel in elements such as gravity columns, long span trusses, belt trusses and outriggers. HISTAR® is the steel “par excellence” for the high-rise buildings columns even in severe earthquake conditions, as seen in the Shanghai World Financial Center (Figure 3.1). There are countless advantages to using HISTAR® steel products, notably:

– **material savings:** HISTAR® steels with higher strength values can significantly reduce the amount of materials used. This result is up to 30% savings in total cost when compared to S355 construction elements.

- **Less weld deposits** as smaller sections are used.
- **Less surface to protect** against corrosion and fire.
- **Less CO<sub>2</sub> emissions:** it reduces carbon emissions by about 30%.
- **Lightness:** due to the high yield strength, the steel tonnage of any element designed by stress can be reduced by around 30% - in some cases even more. Thanks to the lighter construction process, transportation costs are automatically lowered. Depending on the location and availability of equipment on the construction site, smaller cranes or hoists can also be used.

HISTAR® steel always enables economical solutions.

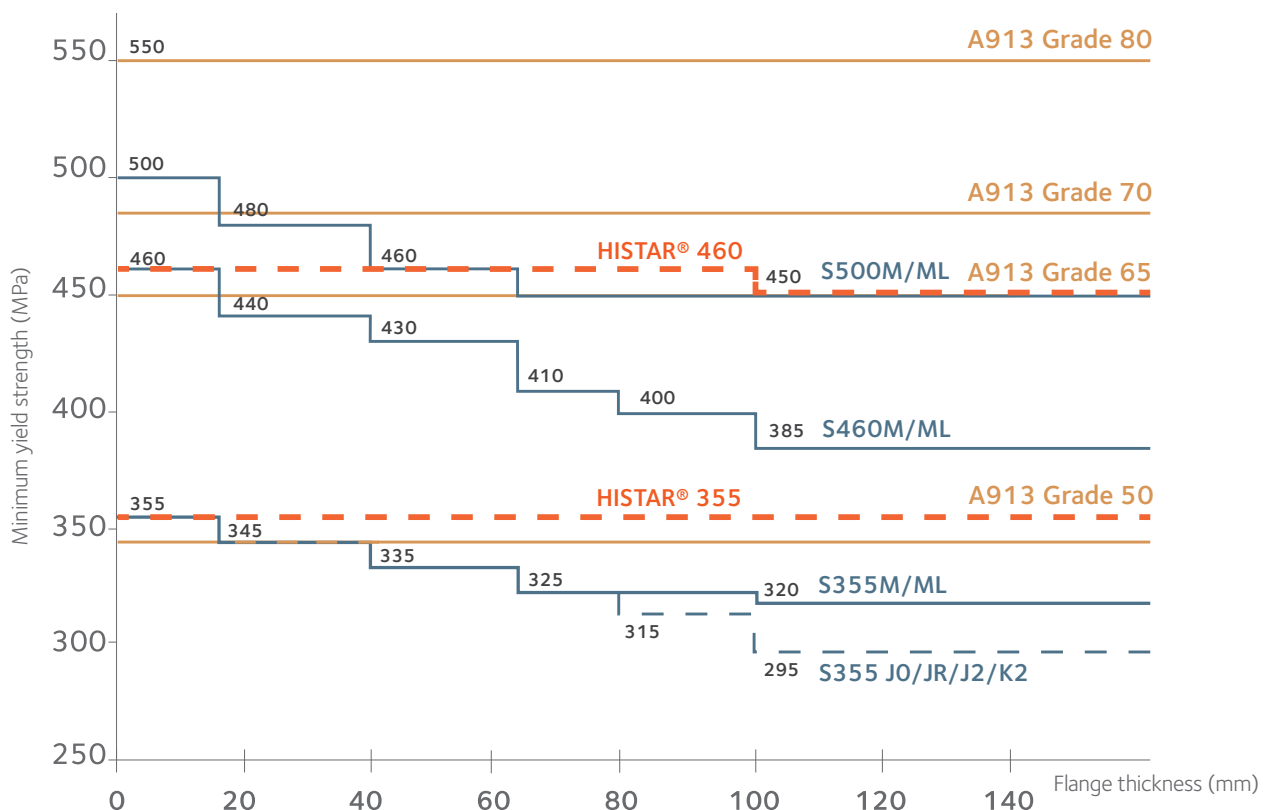

Figure 3.3: Minimum yield strength according to material thickness

*“LeJeune Steel Company has been using A913 Grade 65 for W-shapes since the late 1990s. This steel brings value to projects in the form of improved fabrication and erection efficiencies, as well as reduced material and cost.”*

**Victor Shneur, P.E.**

Chief Engineer

**LEJEUNE**  
STEEL COMPANY

Minneapolis, USA

### — Welding

Provided that the general rules of welding and fabrication are respected (see EN1090-2, EN1011-2 or local codes), HISTAR® grades also offer good weldability for all manual and automatic processes. Due to their low carbon equivalent content, it is generally not necessary to preheat under the following conditions:

- Heat input Q ranges 10-60kJ/cm
- Temperature of the product is > 5 °C
- Electrodes with low carbon equivalent and low hydrogen content, typically with a diffusible hydrogen content ≤ H10 for HISTAR® 355 and ≤ H5 for HISTAR® 460, are used. The welding of a Jumbo beam of 140mm flange thickness in HISTAR® 460 was welded without (see photo below) preheating with a filler metal with low hydrogen content ≤ H5.

Additional cost savings can be achieved using HISTAR®. The volume to be welded can significantly be reduced by 35-40% in function of the groove detail. This induces a total welding time saving by 40% to 50% in function of the welding process and the preheating. Energy consumption can also be further saved. Moreover, under normal conditions, fabrication such as machining, thermal cutting, stress relieving, flame straightening and cold forming can be performed under the same conditions as structural steels with the same level of tensile strength.

For the American steel grades ASTM A913 Gr 50, 65 and 70, minimum preheat temperature to use it as prequalified steel grades are given in Table 3.3 of AWS D1.1:2015. Preheating can be avoided for Grade 50 and 65 when maximum H8 filler metals are used. For Grade 70, a minimum preheat temperature as defined in the table 3.3 shall be applied according to the material thickness.

Nevertheless, some preheating\* may be required in case of:

- ambient T° < 5 °C
- high hydrogen content
- high restraint conditions (leading, for example, to high tri-axial shrinkage stresses)
- low heat input
- special applications.

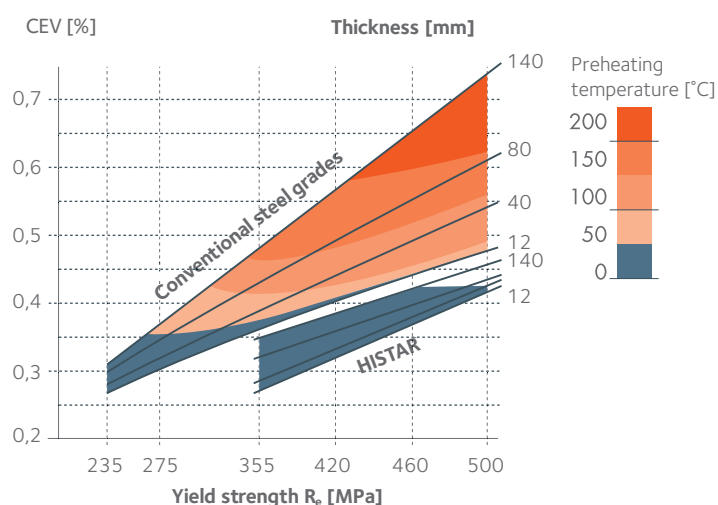

$$CEV (\%) = C + \frac{Mn}{6} + \frac{(Cr+Mo+V)}{5} + \frac{(Cu+Ni)}{15}$$

**Figure 3.4: Preheating temperatures for conventional structural steel grades and HISTAR® grades.**

**No preheat conditions\* for HISTAR® grades:**

- For  $R_e < 460$ :  $H_2 \leq 10\text{ml} / 100\text{g}$
- For  $R_e \geq 460$ :  $H_2 \leq 5\text{ml} / 100\text{g}$
- $Q > 10 \text{ kJ/cm}$



**Figure 3.5: Welding of HISTAR® structural steel grades without preheating\* (CJP\_Complete Joint Penetration\_splice of HD400 x 1299 in HISTAR® 460)**

\* More information can be found within the ArcelorMittal HISTAR® brochure, and for further questions, contact [sections.sales@arcelormittal.com](mailto:sections.sales@arcelormittal.com).

## 4. Columns

Steel is the most efficient material for slender columns thanks to its stiffness and resistance. Compared to concrete, steel is 5 to 8 times stiffer and 10 times more resistant in compression. This makes steel sections the ideal material for columns in tall buildings.

- **Steel sections**

The example in Figure 4.1 shows how a typical 185m high office building of 50 storeys, with a reinforced concrete core, can use HISTAR® columns for most of the internal and façade columns (HISTAR® 460 in this case). In this example, the floor's dead and live loads are 5kN/m<sup>2</sup> and 3kN/m<sup>2</sup>, respectively, and the span between the columns is between 10 and 12 meters.

Combined with the high-strength steel HISTAR® 460, HD 400 / UC 356 / W14 x 16 series enable coverage of almost the whole height of the building. Sizes for an internal column are shown here.

HD/W/UC steel columns have the advantage of having the same distance  $h_i$  between the flanges. In this way two HD/UC/W columns can be piled up on each other so that they can easily be spliced (Figure 4.2).

- **Jumbos and SuperJumbos**

To accommodate additional loads, Jumbo and Super Jumbo sections can be used. Jumbos ( $G > 500 \text{ kg/m}$ ) and Super Jumbos ( $G > 1000 \text{ kg/m}$ ) are very heavy rolled wide flange sections, due to a significant increase in flange thickness. The illustration here shows HD 400 with flange thickness up to 140mm (5.5in.) and with weight up to 1299kg/m (873lbs/ft). In larger sections, such as the HL 920 series, the weight can go up to 1377kg/m (925lbs/ft). ArcelorMittal has the record of the heaviest and the thickest rolled shape in the world (see page 9). When loads are too heavy for the strongest single Super Jumbo such as in the first three floors of the example (Figure 4.2), optimised section such as **HD Box** can be used (Figure 4.3).

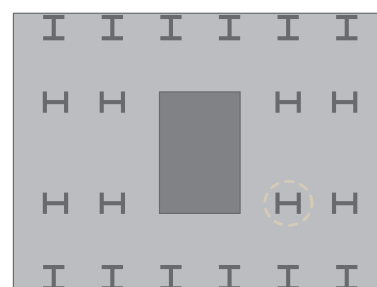
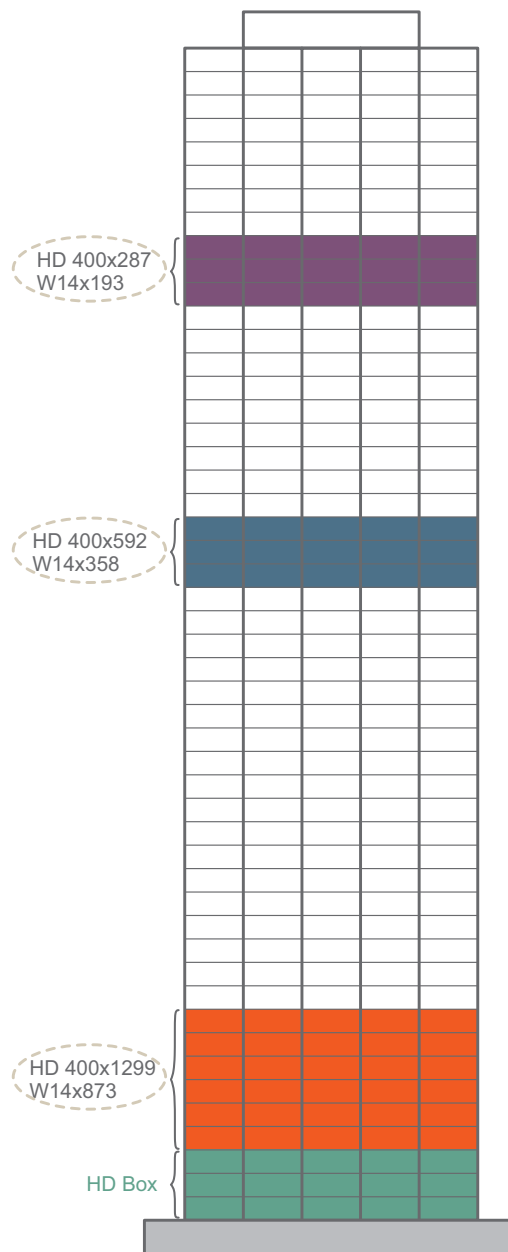

Figure 4.1: 185m high office building

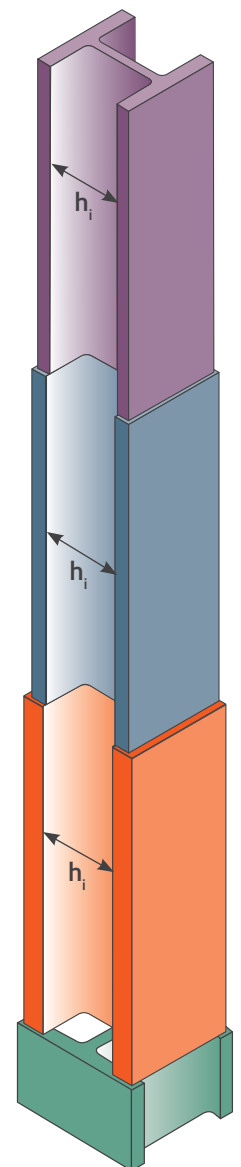

Figure 4.2: Stacking up HD 400 columns.

$h_i$  is constant within a family of sections



- **Optimised built-up sections**

Optimised sections can provide more design flexibility. ArcelorMittal supplies numerous varieties of these welded sections, such as HD Box, cruciform section, sections with

cover plates and several different welded sections. Pages 24 and 25 show design tables for specific HD Box & cruciform sections made of HD/HL/W sections to which two tees, split from the same sections, are welded.



Figure 4.3: HD Box, made from 2 HD

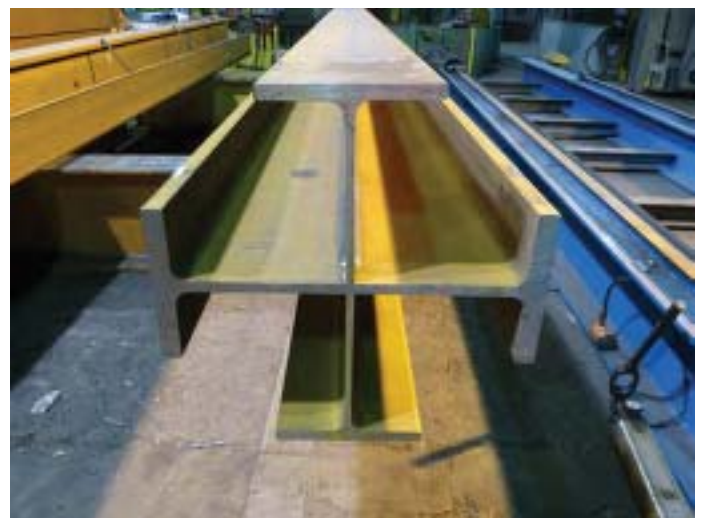

Figure 4.4: Cruciform section

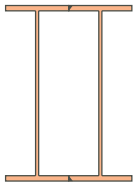

Figure 4.5: Rolled section with coverplates

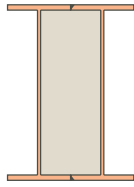

Figure 4.6: Two heavy sections welded together

• Optimised Sections Solutions



Box section welded from two sections



Composite column: box section welded from two sections with concrete filling

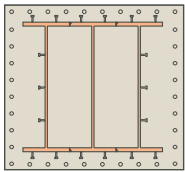

Composite column: box section welded from three sections encased in concrete

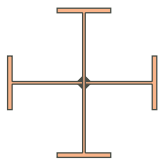

Cruciform section made out of one rolled section and two T-sections

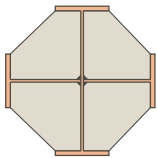

Composite column: cruciform beam with concrete filling

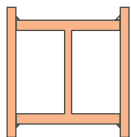

Wide flange beam boxed with two plates

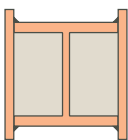

Composite column: wide flange beam boxed with two plates filled with concrete



Box HD section made out of one rolled section and two T sections

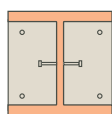

Partially encased composite beam or column

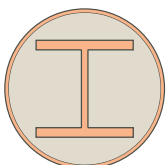

Composite column: wide flange sections encased in concrete filled steel tube

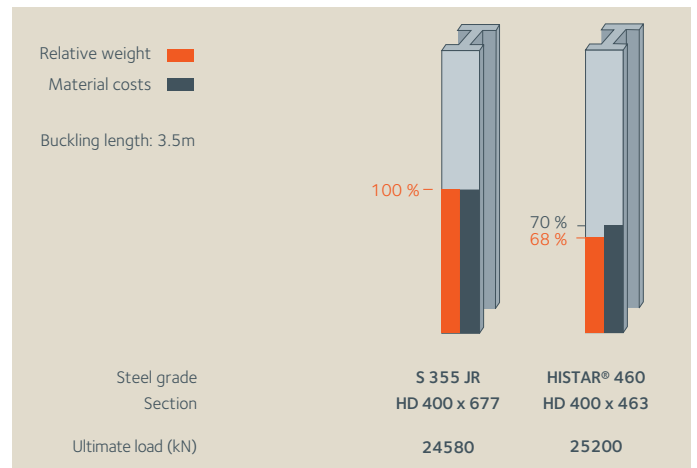

Figure 4.7: Economical use of HISTAR®: heavy columns

Heavy columns:

Gains, when using HISTAR® 460 instead of S355 JR steel:

- 32% weight savings
- 30% costs savings

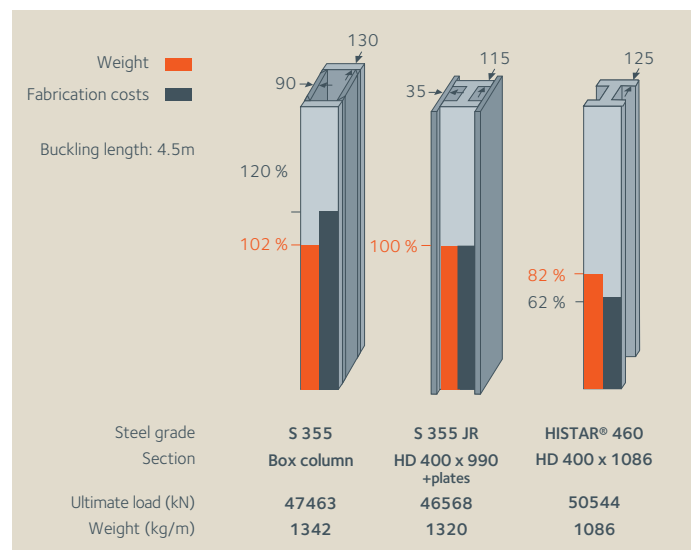

Figure 4.8: Economical use of HISTAR®: built-up sections

Built-up sections:

Gains, when using S355 cover plated column compared to S355 Box column:

2% weight savings -> 20% costs savings

Gains, when using HISTAR® 460 Super Jumbo compared to cover plated S355 JR Jumbo:

18% weight savings -> 38% costs savings

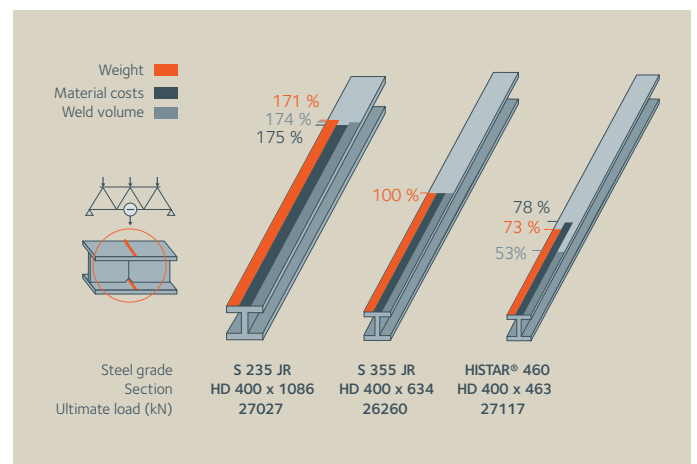
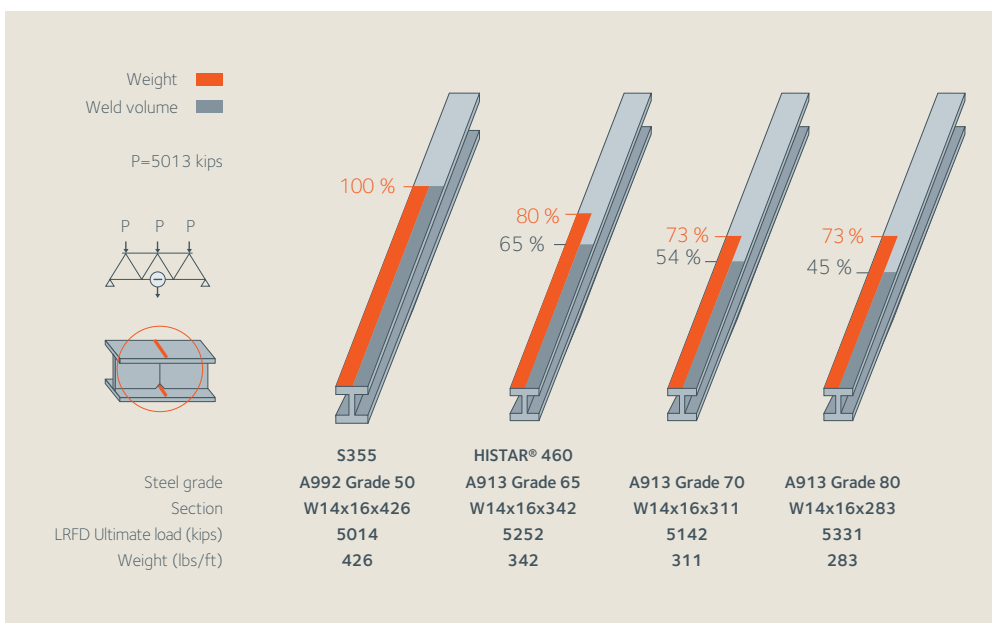
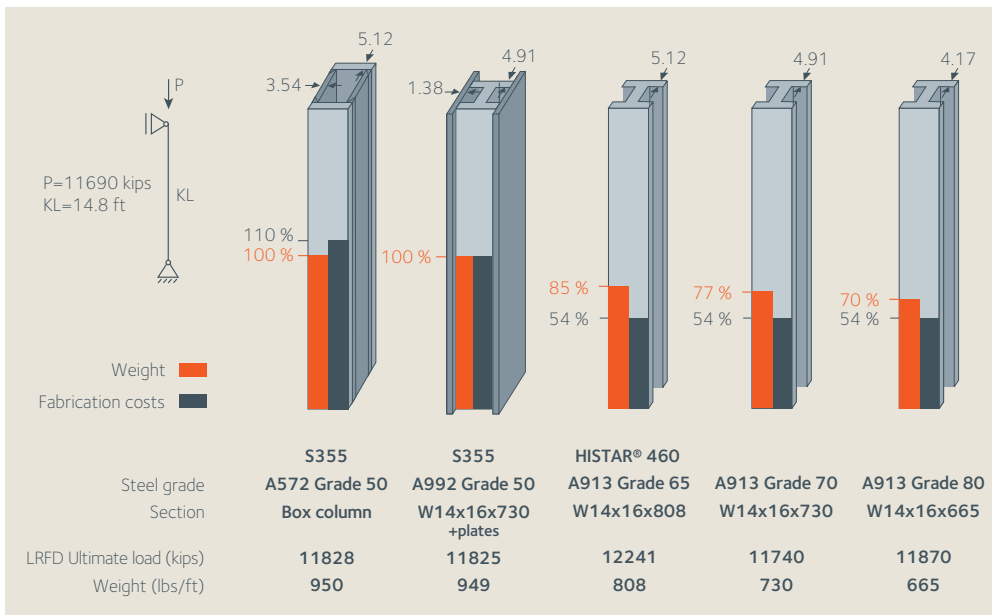
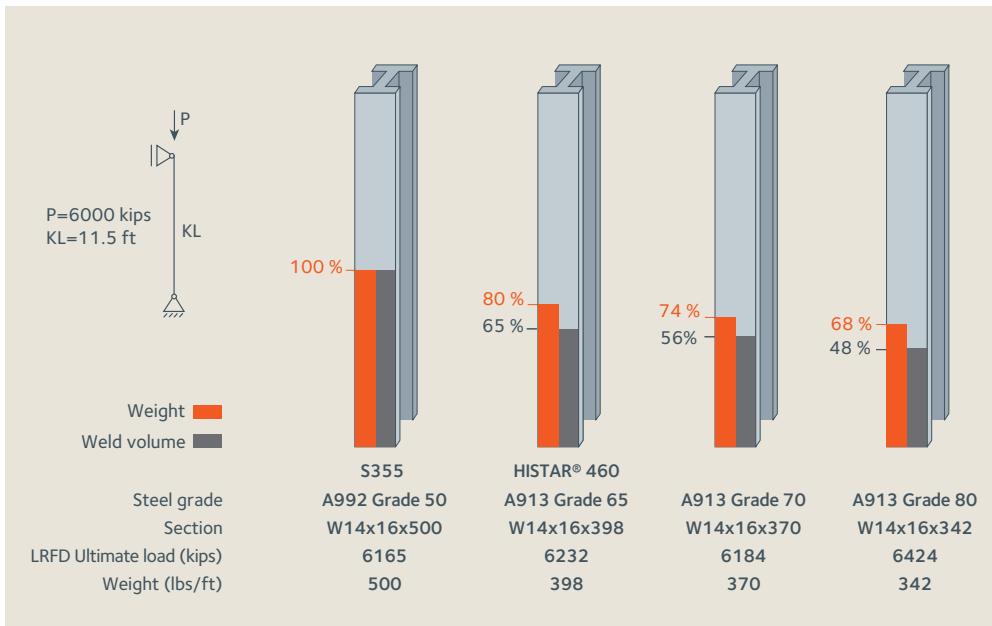

Figure 4.9: Economical use of HISTAR®: beams in truss applications





- HTM / WTM Web Tailor-Made Shape

To offer architects and engineers a solution for increasingly tall and slim buildings, with optimal net floor area, we now produce Web Tailor-Made (WTM / HTM) shapes to complement HISTAR® shapes.

This new product has maximum dimensions of 40" width (1 016 mm) by 4" thick (101,6 mm), and it allows something particularly unique like HISTAR®/ASTM A913 shapes, WTM/HTM products are hot-rolled with the same thermo-mechanical controlled process with in-line quenching and self-tempering (TMCP-QST), thereby enabling the elements to be welded without preheat like HISTAR/ASTM A913 shapes.



Figure 4.10: New development: Web Tailor-Made

### 25 WTM/HTM sizes available

Product designation of WTM/HTM is width x unit weight (lbs/ft respectively kg/m)

Épaisseur/Thickness/Stärke (pouce/inch/zoll)	Largeur/Width/Breite (pouce/inch/zoll)				
	24	28	32	36	40
4	WTM 24 x 327	WTM 28 x 381	WTM 32 x 436	WTM 36 x 490	WTM 40 x 544
3,5	WTM 24 x 286	WTM 28 x 333	WTM 32 x 381	WTM 36 x 429	WTM 40 x 476
3	WTM 24 x 245	WTM 28 x 286	WTM 32 x 327	WTM 36 x 368	WTM 40 x 408
2,75	WTM 24 x 225	WTM 28 x 262	WTM 32 x 299	WTM 36 x 337	WTM 40 x 374
2,5	WTM 24 x 204	WTM 28 x 238	WTM 32 x 272	WTM 36 x 306	WTM 40 x 340

Épaisseur/Thickness/Stärke (mm)	Largeur/Width/Breite (mm)				
	609,6	711,2	812,8	914,4	1 016
101,6	HTM 610 x 486	HTM 710 x 567	HTM 810 x 648	HTM 915 x 729	HTM 1 016 x 810
88,9	HTM 610 x 425	HTM 710 x 496	HTM 810 x 567	HTM 915 x 638	HTM 1 016 x 709
76,2	HTM 610 x 365	HTM 710 x 425	HTM 810 x 486	HTM 915 x 547	HTM 1 016 x 608
69,8	HTM 610 x 334	HTM 710 x 390	HTM 810 x 446	HTM 915 x 501	HTM 1 016 x 557
63,5	HTM 610 x 304	HTM 710 x 355	HTM 810 x 405	HTM 915 x 456	HTM 1 016 x 506

### Comparison between solutions

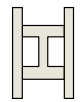
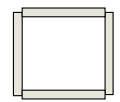
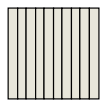
		 reference			
Axial compression					
Buckling Length = 31 ft (9.5 m)		W 14 x 873 (W 360 x 1 299)	W 14 x 873 + 2 x WTM 40 x 544 (HD 400 x 1 299 + 2 x WTM 1 016 x 810)	Box of 4 x WTM 40 x 544 (WTM 1 016 x 810)	Stack of 10 x WTM 40 x 544 (WTM 1 016 x 810)
Weight	lbs/ft	873	1 961	2 181	5 440
	(kg/m)	(1 299)	(2 919)	(3 240)	(8 100)
	%	100	225	250	623
Max. Axial Load	kips (kN)	8 604 (38 273)	28 835 (128 646)	35 642 (159 080)	84 260 (378 239)
	%	100	335	414	979
	% weight	100	149	166	157
Inertia, weak axis	in. <sup>4</sup> (cm <sup>4</sup> )	6 111 (254 372)	48 184 (1 994 075)	171 095 (7 121 545)	200 210 (8 879 604)
	%	100	788	2 800	3 276
	% weight	100	351	1 121	526
Inertia, strong axis	in. <sup>4</sup> (cm <sup>4</sup> )	18 129 (754 600)	60 866 (2 530 521)	197 975 (8 240 377)	200 210 (8 333 333)
	%	100	336	1 092	1 104
	% weight	100	149	437	177

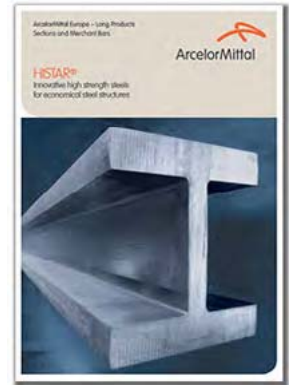

• **Predesign tools, design tables:**

Different design tables exist according to different standards (European, British, American etc.). Here are some examples.

	Axis	Buckling length [m]																
		1	1,5	2	2,5	3	3,5	4	5	6	7	8	9	10	11	12	13	14
HD 400 x 1299	N <sub>b,y,Rd</sub>	74300	74300	74300	74300	74100	73600	73000	71800	70500	69000	67400	65500	63300	60800	57900	54700	51200
	N <sub>b,z,Rd</sub>	74300	74300	73300	71700	70000	68300	66500	62400	57700	52400	46700	41200	36000	31500	27600	24300	21500
HD 400 x 1202	N <sub>b,y,Rd</sub>	68900	68900	68900	68900	68700	68100	67600	66400	65100	63700	62100	60300	58100	55600	52800	49600	46300
	N <sub>b,z,Rd</sub>	68900	68900	67800	66300	64800	63200	61400	57500	53000	48000	42700	37500	32700	28600	25000	21900	19400
HD 400 x 1086	N <sub>b,y,Rd</sub>	62400	62400	62400	62400	62200	61700	61200	60100	59000	57700	56200	54500	52600	50300	47700	44800	41700
	N <sub>b,z,Rd</sub>	62400	62400	61300	59900	58500	56900	55300	51600	47300	42600	37600	32800	28500	24800	21700	19000	16800
HD 400 x 990	N <sub>b,y,Rd</sub>	56800	56800	56800	56800	56600	56100	55600	54600	53600	52300	50900	49300	47400	45200	42700	40000	37100
	N <sub>b,z,Rd</sub>	56800	56800	55800	54500	53100	51700	50100	46700	42700	38300	33700	29300	25500	22100	19300	16900	14900
HD 400 x 900	N <sub>b,y,Rd</sub>	51700	51700	51700	51700	51400	51000	50600	49600	48600	47400	46100	44500	42700	40600	38200	35600	32900
	N <sub>b,z,Rd</sub>	51700	51700	50700	49500	48200	46900	45500	42300	38500	34400	30200	26200	22700	19700	17100	15000	13200
HD 400 x 818	N <sub>b,y,Rd</sub>	48000	48000	48000	48000	47700	47200	46800	45900	44900	43800	42400	40900	39000	36900	34500	32000	29400
	N <sub>b,z,Rd</sub>	48000	48000	47300	46600	45800	45000	44000	41700	38600	34700	30400	26200	22400	19200	16600	14400	12600
HD 400 x 744	N <sub>b,y,Rd</sub>	43600	43600	43600	43600	43300	42900	42500	41600	40700	39600	38300	36900	35100	33100	30800	28400	26100
	N <sub>b,z,Rd</sub>	43600	43600	43000	42300	41600	40800	39900	37700	34800	31200	27200	23300	19900	17100	14700	12800	11200
HD 400 x 677	N <sub>b,y,Rd</sub>	39700	39700	39700	39700	39400	39000	38600	37800	37000	35900	34700	33300	31600	29700	27500	25300	23100
	N <sub>b,z,Rd</sub>	39700	39700	39100	38500	37800	37100	36300	34200	31500	28200	24500	20900	17800	15300	13100	11400	9970
HD 400 x 634	N <sub>b,y,Rd</sub>	37200	37200	37200	37200	36800	36500	36100	35400	34500	33500	32400	31000	29400	27500	25500	23400	21300
	N <sub>b,z,Rd</sub>	37200	37100	36600	36000	35400	34700	33900	31900	29300	26100	22600	19300	16500	14100	12100	10500	9180
HD 400 x 592	N <sub>b,y,Rd</sub>	34700	34700	34700	34700	34400	34100	33700	33000	32200	31300	30100	28800	27300	25500	23500	21600	19600
	N <sub>b,z,Rd</sub>	34700	34700	34200	33600	33000	32300	31600	29700	27300	24200	20900	17800	15200	12900	11100	9650	8440
HD 400 x 551	N <sub>b,y,Rd</sub>	32300	32300	32300	32200	31900	31600	31300	30600	29800	28900	27900	26600	25100	23400	21600	19700	17900
	N <sub>b,z,Rd</sub>	32300	32200	31700	31200	30600	30000	29300	27500	25200	22300	19300	16400	13900	11900	10200	8840	7730
HD 400 x 509	N <sub>b,y,Rd</sub>	29900	29900	29900	29800	29500	29200	28900	28300	27600	26700	25700	24500	23100	21500	19700	18000	16300
	N <sub>b,z,Rd</sub>	29900	29800	29300	28900	28300	27700	27100	25400	23200	20500	17700	15000	12700	10900	9340	8090	7070
HD 400 x 463	N <sub>b,y,Rd</sub>	27100	27100	27100	27000	26800	26500	26200	25600	25000	24200	23200	22100	20700	19200	17600	16000	14500
	N <sub>b,z,Rd</sub>	27100	27100	26600	26200	25700	25200	24500	23000	21000	18500	15800	13400	11400	9690	8320	7210	6300
HD 400 x 421	N <sub>b,y,Rd</sub>	24700	24700	24700	24600	24400	24100	23900	23300	22700	21900	21000	20000	18700	17300	15800	14300	12900
	N <sub>b,z,Rd</sub>	24700	24600	24300	23800	23400	22900	22300	20900	19000	16700	14300	12100	10200	8700	7470	6470	5650
HD 400 x 382	N <sub>b,y,Rd</sub>	22400	22400	22400	22300	22100	21900	21600	21100	20500	19800	19000	18000	16800	15500	14100	12800	11500
	N <sub>b,z,Rd</sub>	22400	22300	22000	21600	21200	20700	20200	18900	17100	15000	12800	10800	9150	7790	6680	5780	5050
HD 400 x 347	N <sub>b,y,Rd</sub>	20300	20300	20300	20200	20000	19800	19600	19100	18600	17900	17100	16200	15100	13900	12600	11400	10300
	N <sub>b,z,Rd</sub>	20300	20300	19900	19600	19200	18800	18300	17100	15500	13500	11500	9730	8220	6990	6000	5190	4530
HD 400 x 314	N <sub>b,y,Rd</sub>	18400	18400	18400	18300	18100	17900	17700	17300	16700	16100	15400	14500	13500	12400	11200	10100	9110
	N <sub>b,z,Rd</sub>	18400	18300	18000	17700	17300	16900	16500	15400	13900	12100	10300	8660	7310	6210	5330	4610	4020
HD 400 x 287	N <sub>b,y,Rd</sub>	16800	16800	16800	16800	16600	16400	16200	15800	15300	14800	14100	13300	12300	11300	10200	9210	8270
	N <sub>b,z,Rd</sub>	16800	16800	16500	16200	15900	15500	15100	14100	12700	11100	9380	7900	6660	5660	4850	4200	3660
HD 400 x 262	N <sub>b,y,Rd</sub>	15400	15400	15400	15300	15100	15000	14800	14400	14000	13500	12800	12100	11200	10200	9240	8310	7450
	N <sub>b,z,Rd</sub>	15400	15300	15100	14800	14500	14200	13800	12800	11600	10000	8500	7150	6030	5120	4390	3800	3310
HD 400 x 237	N <sub>b,y,Rd</sub>	13800	13800	13800	13700	13600	13500	13300	13000	12600	12100	11500	10800	9970	9090	8200	7360	6600
	N <sub>b,z,Rd</sub>	13800	13800	13600	13300	13000	12700	12400	11500	10300	8950	7570	6360	5350	4550	3890	3370	2940
HD 400 x 216	N <sub>b,y,Rd</sub>	12700	12700	12700	12600	12500	12300	12200	11900	11500	11000	10500	9830	9070	8260	7450	6680	5980
	N <sub>b,z,Rd</sub>	12700	12600	12400	12200	11900	11700	11300	10500	9440	8170	6900	5790	4880	4140	3550	3070	2680

**Table 4.1: Eurocode (EN 1993-1-1: 2005) design buckling resistance [kN] of strong and weak axis of HD columns sections in HISTAR® 460.**

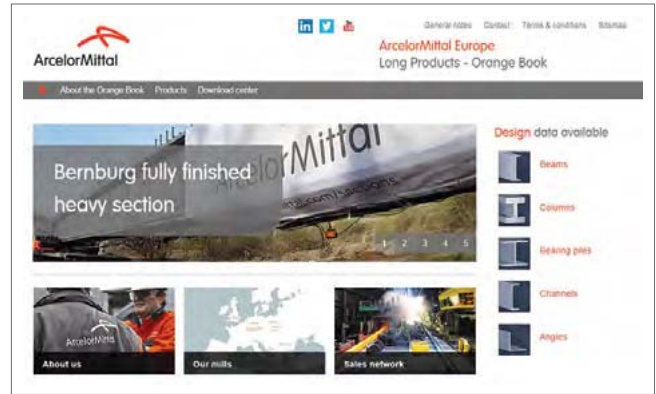

	Axis	Buckling length [m]																
		1	1,5	2	2,5	3	3,5	4	5	6	7	8	9	10	11	12	13	14
HD 400 x 187	N <sub>b,y,Rd</sub>	10900	10900	10900	10800	10700	10600	10500	10200	9880	9480	9000	8420	7760	7050	6340	5680	5080
	N <sub>b,z,Rd</sub>	10900	10900	10700	10500	10300	10000	9750	9040	8090	6970	5880	4920	4140	3510	3010	2600	2270
HD 360 x 196	N <sub>b,y,Rd</sub>	11500	11500	11500	11400	11300	11200	11000	10800	10400	10000	9490	8880	8190	7440	6700	6000	5360
	N <sub>b,z,Rd</sub>	11500	11400	11200	11000	10800	10500	10100	9290	8180	6930	5770	4790	4010	3390	2900	2500	2180
HD 360 x 179	N <sub>b,y,Rd</sub>	10500	10500	10500	10400	10300	10200	10100	9800	9490	9100	8640	8070	7430	6750	6070	5430	4850
	N <sub>b,z,Rd</sub>	10500	10400	10200	10000	9800	9540	9240	8460	7430	6290	5230	4340	3640	3070	2630	2270	1970
HD 360 x 162	N <sub>b,y,Rd</sub>	9490	9490	9490	9420	9310	9210	9100	8850	8570	8220	7790	7280	6690	6070	5460	4880	4360
	N <sub>b,z,Rd</sub>	9490	9420	9240	9060	8850	8620	8340	7630	6690	5660	4700	3900	3270	2760	2360	2040	1770
HD 360 x 147	N <sub>b,y,Rd</sub>	8640	8640	8640	8570	8480	8380	8280	8060	7790	7470	7070	6600	6060	5490	4920	4400	3930
	N <sub>b,z,Rd</sub>	8640	8570	8420	8250	8060	7840	7590	6930	6070	5120	4250	3520	2950	2490	2130	1840	1600
HD 360 x 134	N <sub>b,y,Rd</sub>	7850	7850	7850	7780	7700	7610	7510	7310	7060	6760	6400	5960	5470	4950	4430	3960	3530
	N <sub>b,z,Rd</sub>	7850	7780	7640	7490	7310	7110	6880	6280	5490	4630	3840	3180	2660	2250	1920	1660	1440
HD 320 x 300	N <sub>b,y,Rd</sub>	17600	17600	17600	17400	17200	17000	16800	16300	15700	15000	14100	13000	11800	10600	9480	8420	7490
	N <sub>b,z,Rd</sub>	17600	17300	16900	16400	15900	15300	14500	12600	10300	8270	6660	5430	4490	3770	3200	2760	2390
HD 320 x 245	N <sub>b,y,Rd</sub>	14400	14400	14300	14200	14000	13800	13700	13200	12700	12100	11400	10500	9470	8470	7520	6670	5920
	N <sub>b,z,Rd</sub>	14400	14100	13800	13400	13000	12400	11800	10200	8310	6650	5350	4360	3600	3020	2570	2210	1920
HD 320 x 198	N <sub>b,y,Rd</sub>	11600	11600	11600	11500	11300	11200	11000	10700	10200	9690	9020	8250	7410	6580	5820	5140	4550
	N <sub>b,z,Rd</sub>	11600	11400	11100	10800	10400	10000	9460	8080	6550	5210	4180	3400	2810	2360	2000	1720	1490
HD 320 x 158	N <sub>b,y,Rd</sub>	9260	9260	9230	9120	9010	8890	8760	8460	8100	7650	7090	6450	5760	5100	4490	3960	3500
	N <sub>b,z,Rd</sub>	9260	9070	8850	8600	8300	7930	7480	6350	5110	4060	3250	2640	2180	1830	1550	1330	1160
HD 320 x 127	N <sub>b,y,Rd</sub>	7420	7420	7390	7310	7210	7110	7010	6770	6470	6090	5630	5090	4540	4000	3520	3100	2740
	N <sub>b,z,Rd</sub>	7420	7260	7080	6880	6630	6330	5960	5020	4020	3180	2540	2060	1700	1430	1210	1040	904
HD 320 x 97,6	N <sub>b,y,Rd</sub>	5720	5720	5700	5630	5550	5480	5390	5200	4960	4650	4280	3860	3420	3010	2640	2320	2050
	N <sub>b,z,Rd</sub>	5720	5600	5460	5290	5100	4860	4570	3830	3060	2410	1930	1560	1290	1080	917	788	684
HD 320 x 74,2*	N <sub>b,y,Rd</sub>	4220	4220	4200	4150	4090	4030	3970	3820	3640	3410	3120	2800	2480	2170	1900	1670	1470
	N <sub>b,z,Rd</sub>	4220	4120	4010	3890	3740	3560	3330	2770	2190	1730	1370	1110	918	769	653	561	487
HD 260 x 299	N <sub>b,y,Rd</sub>	17500	17500	17400	17200	16900	16700	16400	15700	14900	13900	12600	11300	9880	8620	7520	6590	5800
	N <sub>b,z,Rd</sub>	17500	17100	16600	16100	15400	14600	13700	11200	8840	6930	5510	4460	3670	3070	2610	2240	1940
HD 260 x 225	N <sub>b,y,Rd</sub>	13200	13200	13100	12900	12700	12500	12300	11700	11000	10100	9100	7990	6940	6010	5220	4550	4000
	N <sub>b,z,Rd</sub>	13100	12800	12500	12000	11500	10900	10100	8160	6350	4950	3920	3170	2610	2180	1850	1590	1380
HD 260 x 172	N <sub>b,y,Rd</sub>	10100	10100	9990	9850	9690	9520	9340	8900	8320	7590	6740	5860	5060	4360	3770	3290	2880
	N <sub>b,z,Rd</sub>	10100	9820	9540	9210	8800	8280	7650	6160	4780	3710	2940	2370	1950	1630	1380	1190	1030
HD 260 x 142	N <sub>b,y,Rd</sub>	8290	8290	8190	8070	7940	7790	7630	7250	6740	6100	5370	4640	3980	3420	2960	2570	2250
	N <sub>b,z,Rd</sub>	8260	8050	7810	7530	7180	6730	6190	4930	3800	2940	2330	1880	1540	1290	1090	938	814
HD 260 x 114	N <sub>b,y,Rd</sub>	6700	6700	6610	6510	6400	6280	6150	5820	5390	4850	4240	3650	3120	2680	2310	2010	1760
	N <sub>b,z,Rd</sub>	6670	6490	6300	6060	5770	5400	4940	3910	3000	2320	1830	1470	1210	1010	858	736	638
HD 260 x 93,0	N <sub>b,y,Rd</sub>	5450	5450	5370	5280	5190	5090	4980	4710	4350	3890	3390	2910	2480	2120	1830	1590	1390
	N <sub>b,z,Rd</sub>	5410	5270	5110	4920	4670	4360	3980	3130	2390	1850	1460	1170	965	806	683	586	508
HD 260 x 68,2	N <sub>b,y,Rd</sub>	3990	3990	3930	3870	3800	3720	3630	3420	3140	2790	2420	2060	1750	1500	1290	1120	977
	N <sub>b,z,Rd</sub>	3970	3860	3740	3590	3410	3170	2890	2260	1720	1320	1040	841	690	577	489	419	363
HD 260 x 54,1*	N <sub>b,y,Rd</sub>	3080	3070	3030	2980	2920	2860	2800	2630	2410	2140	1850	1580	1340	1150	985	854	747
	N <sub>b,z,Rd</sub>	3050	2970	2880	2760	2620	2430	2210	1720	1310	1010	794	640	525	439	372	319	276

Table 4.1 (continued): Eurocode (EN 1993-1-1: 2005) design buckling resistance [kN] of strong and weak axis of HD columns sections in HISTAR® 460.

\* Only available in S460M.

	Axis	Buckling length [m]																
		1	1,5	2	2,5	3	3,5	4	5	6	7	8	9	10	11	12	13	14
UC 356 x 406 x 1299	N <sub>b,y,Rd</sub>	74500	74500	74500	74500	74400	73800	73200	72000	70700	69200	67600	65700	63500	60900	58000	54800	51300
	N <sub>b,z,Rd</sub>	74500	74500	73500	71900	70200	68500	66600	62500	57800	52500	46800	41200	36100	31500	27600	24300	21500
UC 356 x 406 x 1202	N <sub>b,y,Rd</sub>	68900	68900	68900	68900	68700	68200	67600	66400	65200	63800	62200	60300	58100	55600	52800	49600	46300
	N <sub>b,z,Rd</sub>	68900	68900	67900	66400	64800	63200	61400	57600	53100	48000	42700	37500	32700	28500	25000	21900	19400
UC 356 x 406 x 1086	N <sub>b,y,Rd</sub>	62400	62400	62400	62400	62200	61700	61200	60100	59000	57700	56200	54500	52500	50300	47600	44800	41700
	N <sub>b,z,Rd</sub>	62400	62400	61300	59900	58400	56900	55300	51600	47300	42600	37600	32800	28500	24800	21700	19000	16800
UC 356 x 406 x 990	N <sub>b,y,Rd</sub>	56800	56800	56800	56800	56600	56100	55700	54700	53600	52300	50900	49300	47400	45200	42700	40000	37100
	N <sub>b,z,Rd</sub>	56800	56800	55800	54500	53100	51700	50200	46700	42700	38300	33700	29300	25400	22100	19300	16900	14900
UC 356 x 406 x 900	N <sub>b,y,Rd</sub>	51700	51700	51700	51700	51400	51000	50600	49600	48600	47400	46100	44500	42700	40600	38200	35600	32900
	N <sub>b,z,Rd</sub>	51700	51700	50700	49500	48200	46900	45500	42300	38600	34400	30200	26200	22700	19700	17100	15000	13200
UC 356 x 406 x 818	N <sub>b,y,Rd</sub>	48000	48000	48000	48000	47700	47300	46800	45900	44900	43800	42400	40900	39000	36900	34500	32000	29400
	N <sub>b,z,Rd</sub>	48000	48000	47300	46600	45800	45000	44000	41700	38600	34700	30400	26200	22400	19200	16600	14400	12600
UC 356 x 406 x 744	N <sub>b,y,Rd</sub>	43600	43600	43600	43600	43300	42900	42500	41600	40700	39600	38300	36900	35100	33100	30800	28400	26100
	N <sub>b,z,Rd</sub>	43600	43600	43000	42300	41600	40800	39900	37700	34800	31200	27200	23300	19900	17100	14700	12800	11200
UC 356 x 406 x 677	N <sub>b,y,Rd</sub>	39700	39700	39700	39700	39400	39000	38600	37800	36900	35900	34700	33300	31600	29700	27500	25300	23100
	N <sub>b,z,Rd</sub>	39700	39700	39100	38500	37800	37100	36300	34200	31500	28200	24500	20900	17800	15300	13100	11400	9970
UC 356 x 406 x 634	N <sub>b,y,Rd</sub>	37100	37100	37100	37100	36800	36500	36100	35400	34500	33500	32400	31000	29400	27500	25500	23400	21400
	N <sub>b,z,Rd</sub>	37100	37100	36600	36000	35300	34600	33800	31900	29300	26100	22600	19300	16400	14000	12100	10500	9160
UC 356 x 406 x 592	N <sub>b,y,Rd</sub>	34700	34700	34700	34700	34400	34100	33700	33000	32200	31200	30100	28800	27300	25500	23500	21600	19600
	N <sub>b,z,Rd</sub>	34700	34700	34200	33600	33000	32300	31600	29700	27300	24200	20900	17800	15200	12900	11100	9650	8440
UC 356 x 406 x 551	N <sub>b,y,Rd</sub>	32300	32300	32300	32200	31900	31600	31300	30600	29900	29000	27900	26600	25100	23400	21600	19700	17900
	N <sub>b,z,Rd</sub>	32300	32200	31800	31200	30700	30000	29300	27600	25200	22400	19300	16400	13900	11900	10200	8860	7740
UC 356 x 406 x 509	N <sub>b,y,Rd</sub>	29900	29900	29900	29800	29500	29200	28900	28300	27600	26700	25700	24500	23100	21400	19700	18000	16300
	N <sub>b,z,Rd</sub>	29900	29800	29300	28900	28300	27700	27100	25400	23200	20500	17700	15000	12700	10900	9340	8090	7070
UC 356 x 406 x 467	N <sub>b,y,Rd</sub>	27400	27400	27400	27300	27000	26800	26500	25900	25200	24400	23500	22300	21000	19500	17800	16200	14700
	N <sub>b,z,Rd</sub>	27400	27300	26900	26400	25900	25400	24800	23200	21200	18700	16000	13600	11500	9800	8420	7300	6370
UC 356 x 406 x 393	N <sub>b,y,Rd</sub>	23000	23000	23000	22900	22700	22500	22200	21700	21100	20400	19600	18500	17300	16000	14600	13200	11900
	N <sub>b,z,Rd</sub>	23000	23000	22600	22200	21800	21300	20800	19400	17600	15500	13200	11200	9440	8040	6900	5970	5220
UC 356 x 406 x 340	N <sub>b,y,Rd</sub>	19900	19900	19900	19800	19600	19400	19200	18700	18200	17600	16800	15900	14800	13600	12400	11200	10100
	N <sub>b,z,Rd</sub>	19900	19900	19500	19200	18800	18400	17900	16700	15100	13200	11300	9490	8010	6820	5850	5060	4420
UC 356 x 406 x 287	N <sub>b,y,Rd</sub>	16100	16100	16100	16000	15900	15700	15500	15200	14700	14200	13600	12900	12000	11000	10100	9090	8190
	N <sub>b,z,Rd</sub>	16100	16000	15800	15500	15200	14900	14500	13600	12300	10800	9220	7790	6590	5610	4810	4170	3640
UC 356 x 406 x 235	N <sub>b,y,Rd</sub>	13200	13200	13200	13100	13000	12800	12700	12400	12000	11600	11000	10400	9680	8880	8060	7260	6530
	N <sub>b,z,Rd</sub>	13200	13100	12900	12700	12400	12200	11800	11100	10000	8760	7460	6290	5320	4520	3880	3360	2930

Table 4.2: Eurocode (EN 1993-1-1: 2005) design buckling resistances [kN] of strong and weak axis of UC columns sections in HSTAR® 460.



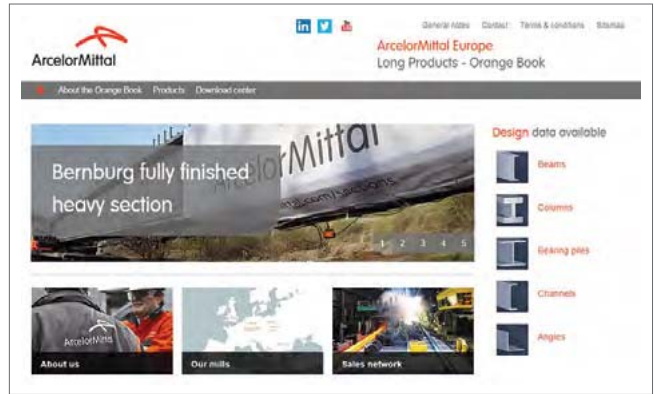

	Axis	Buckling length [m]																
		1	1,5	2	2,5	3	3,5	4	5	6	7	8	9	10	11	12	13	14
UC 356 x 368 x 202	N <sub>b,y,Rd</sub>	11300	11300	11300	11200	11100	11000	10900	10600	10300	9910	9450	8890	8250	7540	6830	6140	5510
	N <sub>b,z,Rd</sub>	11300	11200	11100	10800	10600	10300	10000	9260	8220	7040	5900	4920	4130	3500	2990	2590	2250
UC 356 x 368 x 177	N <sub>b,y,Rd</sub>	9920	9920	9920	9860	9760	9650	9540	9300	9010	8670	8250	7750	7180	6550	5920	5320	4770
	N <sub>b,z,Rd</sub>	9920	9860	9690	9500	9300	9060	8790	8090	7170	6120	5120	4270	3580	3030	2600	2240	1950
UC 356 x 368 x 153	N <sub>b,y,Rd</sub>	8570	8570	8570	8510	8420	8330	8240	8020	7770	7470	7110	6670	6160	5610	5060	4540	4070
	N <sub>b,z,Rd</sub>	8570	8510	8360	8200	8020	7820	7580	6970	6170	5260	4390	3660	3070	2600	2220	1920	1670
UC 356 x 368 x 129	N <sub>b,y,Rd</sub>	7230	7230	7230	7180	7100	7020	6940	6760	6540	6280	5970	5590	5160	4690	4220	3780	3390
	N <sub>b,z,Rd</sub>	7230	7180	7050	6910	6760	6590	6380	5860	5180	4400	3670	3050	2560	2160	1850	1600	1390
UC 305 x 305 x 283	N <sub>b,y,Rd</sub>	16600	16600	16600	16400	16200	16000	15800	15300	14700	14000	13100	12100	10900	9790	8690	7710	6840
	N <sub>b,z,Rd</sub>	16600	16300	16000	15600	15100	14600	13900	12200	10100	8170	6600	5400	4470	3760	3200	2750	2390
UC 305 x 305 x 240	N <sub>b,y,Rd</sub>	13500	13500	13500	13300	13100	13000	12800	12400	12000	11400	10700	9830	8900	7960	7070	6270	5570
	N <sub>b,z,Rd</sub>	13500	13300	13000	12600	12300	11800	11300	9930	8270	6700	5430	4440	3680	3090	2630	2260	1970
UC 305 x 305 x 198	N <sub>b,y,Rd</sub>	11100	11100	11100	11000	10800	10700	10600	10200	9820	9320	8700	7980	7190	6400	5670	5020	4450
	N <sub>b,z,Rd</sub>	11100	10900	10700	10400	10100	9730	9280	8100	6720	5420	4380	3580	2960	2490	2120	1820	1580
UC 305 x 305 x 158	N <sub>b,y,Rd</sub>	8860	8860	8840	8740	8630	8520	8400	8120	7780	7360	6840	6230	5580	4950	4370	3860	3410
	N <sub>b,z,Rd</sub>	8860	8710	8510	8290	8040	7730	7350	6370	5240	4210	3390	2770	2290	1920	1640	1410	1220
UC 305 x 305 x 137	N <sub>b,y,Rd</sub>	7670	7670	7650	7560	7470	7370	7260	7020	6720	6340	5880	5340	4770	4220	3720	3280	2900
	N <sub>b,z,Rd</sub>	7670	7540	7370	7170	6950	6670	6340	5480	4490	3600	2890	2360	1950	1640	1390	1200	1040
UC 305 x 305 x 118	N <sub>b,y,Rd</sub>	6610	6610	6590	6510	6420	6340	6240	6030	5760	5430	5020	4550	4060	3580	3150	2780	2450
	N <sub>b,z,Rd</sub>	6610	6490	6340	6170	5970	5730	5440	4680	3820	3060	2460	2000	1660	1390	1180	1020	883
UC 305 x 305 x 97	N <sub>b,y,Rd</sub>	5680	5680	5650	5580	5500	5420	5340	5140	4900	4590	4210	3780	3340	2930	2570	2260	1990
	N <sub>b,z,Rd</sub>	5680	5560	5430	5270	5090	4870	4600	3900	3140	2500	2000	1620	1340	1120	955	821	713
UC 254 x 254 x 167	N <sub>b,y,Rd</sub>	9370	9370	9270	9140	9000	8850	8680	8290	7770	7120	6350	5550	4800	4150	3600	3140	2750
	N <sub>b,z,Rd</sub>	9340	9110	8860	8550	8180	7720	7140	5780	4490	3500	2770	2240	1840	1540	1310	1120	973
UC 254 x 254 x 132	N <sub>b,y,Rd</sub>	7400	7400	7310	7200	7090	6970	6830	6500	6070	5520	4890	4240	3660	3150	2720	2370	2080
	N <sub>b,z,Rd</sub>	7370	7180	6980	6730	6420	6040	5570	4460	3450	2680	2120	1710	1410	1180	997	856	742
UC 254 x 254 x 107	N <sub>b,y,Rd</sub>	6000	6000	5920	5840	5740	5640	5520	5240	4870	4400	3870	3340	2870	2460	2130	1850	1620
	N <sub>b,z,Rd</sub>	5970	5820	5650	5440	5190	4860	4470	3550	2730	2120	1670	1350	1110	927	786	675	585
UC 254 x 254 x 89	N <sub>b,y,Rd</sub>	4980	4980	4920	4840	4760	4680	4580	4340	4020	3630	3180	2740	2350	2020	1740	1510	1320
	N <sub>b,z,Rd</sub>	4960	4830	4690	4520	4300	4030	3690	2930	2250	1740	1380	1110	911	762	645	554	480
UC 254 x 254 x 73	N <sub>b,y,Rd</sub>	4280	4280	4220	4150	4080	4000	3900	3680	3390	3020	2620	2240	1910	1630	1400	1220	1060
	N <sub>b,z,Rd</sub>	4250	4140	4010	3850	3650	3400	3090	2410	1830	1410	1110	896	736	615	521	447	387

Table 4.2 (continued): Eurocode (EN 1993-1-1: 2005) design buckling resistances [kN] of strong and weak axis of UC columns sections in HISTAR® 460.

Shape		W14 x 16													
lb/ft		873 <sup>h</sup>		808 <sup>h</sup>		730 <sup>h</sup>		665 <sup>h</sup>		605 <sup>h</sup>		550 <sup>h</sup>		500 <sup>h</sup>	
Design		ASD	LRFD	ASD	LRFD	ASD	LRFD	ASD	LRFD	ASD	LRFD	ASD	LRFD	ASD	LRFD
Effective length, KL (ft), with respect to least radius of gyration, ry	0	10000	15030	9260	13920	8370	12580	7630	11470	6930	10410	6310	9480	5720	8600
	11	9340	14030	8630	12970	7760	11670	7060	10610	6400	9610	5810	8730	5260	7900
	12	9210	13850	8510	12790	7650	11500	6960	10450	6300	9470	5720	8590	5170	7780
	13	9080	13650	8390	12610	7530	11320	6850	10290	6200	9310	5620	8450	5090	7640
	14	8950	13450	8260	12410	7410	11130	6730	10110	6090	9150	5520	8300	4990	7500
	15	8800	13220	8120	12200	7270	10930	6600	9930	5970	8970	5410	8130	4890	7350
	16	8640	12990	7970	11980	7140	10730	6470	9730	5850	8790	5300	7970	4790	7190
	17	8480	12750	7820	11750	6990	10510	6340	9530	5720	8600	5180	7790	4680	7030
	18	8320	12500	7660	11510	6840	10280	6200	9310	5590	8410	5060	7610	4560	6860
	19	8140	12240	7500	11270	6680	10050	6050	9100	5460	8200	4930	7420	4450	6690
	20	7960	11970	7330	11010	6520	9810	5900	8870	5320	7990	4810	7220	4330	6510
	22	7590	11410	6970	10480	6190	9310	5590	8410	5030	7560	4540	6820	4080	6140
	24	7200	10830	6610	9930	5850	8790	5270	7920	4730	7120	4260	6410	3830	5750
	26	6800	10230	6230	9360	5490	8260	4950	7430	4430	6660	3980	5990	3570	5370
	28	6400	9620	5850	8790	5140	7720	4610	6940	4130	6200	3700	5570	3310	4980
	30	5990	9000	5460	8210	4780	7180	4280	6440	3820	5740	3420	5140	3050	4590
	32	5580	8390	5080	7630	4420	6650	3960	5950	3520	5290	3150	4730	2800	4210
	34	5180	7780	4700	7070	4080	6130	3640	5460	3230	4850	2880	4320	2550	3840
	36	4780	7180	4330	6510	3740	5620	3320	4990	2940	4420	2620	3930	2320	3480
	38	4390	6600	3970	5970	3410	5120	3020	4540	2660	4000	2360	3550	2090	3130
	40	4020	6040	3620	5450	3090	4640	2730	4100	2400	3610	2130	3200	1880	2830
42	3650	5490	3290	4940	2800	4210	2480	3720	2180	3280	1930	2900	1710	2570	
44	3330	5000	2990	4500	2550	3830	2260	3390	1990	2990	1760	2650	1560	2340	
46	3040	4570	2740	4120	2330	3510	2060	3100	1820	2730	1610	2420	1420	2140	
48	2800	4200	2520	3780	2140	3220	1900	2850	1670	2510	1480	2220	1310	1960	
50	2580	3870	2320	3480	1970	2970	1750	2630	1540	2310	1360	2050	1200	1810	

Shape		W14 x 16													
lb/ft		455 <sup>h</sup>		426 <sup>h</sup>		398 <sup>h</sup>		370 <sup>h</sup>		342 <sup>h</sup>		311 <sup>h</sup>		283 <sup>h</sup>	
Design		ASD	LRFD	ASD	LRFD	ASD	LRFD	ASD	LRFD	ASD	LRFD	ASD	LRFD	ASD	LRFD
Effective length, KL (ft), with respect to least radius of gyration, ry	0	5220	7840	4870	7310	4550	6840	4240	6380	3930	5910	3560	5350	3240	4870
	11	4780	7190	4460	6700	4170	6260	3870	5820	3590	5390	3240	4870	2950	4430
	12	4710	7070	4380	6590	4100	6160	3810	5720	3520	5290	3180	4780	2890	4350
	13	4620	6950	4300	6470	4020	6040	3740	5620	3460	5200	3120	4690	2840	4270
	14	4530	6820	4220	6340	3940	5920	3660	5500	3390	5090	3060	4590	2780	4180
	15	4440	6680	4130	6210	3860	5800	3580	5390	3310	4980	2990	4490	2720	4080
	16	4340	6530	4040	6070	3770	5670	3500	5260	3230	4860	2920	4380	2650	3980
	17	4240	6380	3940	5930	3680	5530	3420	5130	3150	4740	2840	4270	2580	3880
	18	4140	6220	3840	5780	3590	5390	3330	5000	3070	4620	2770	4160	2510	3780
	19	4030	6060	3740	5630	3490	5250	3240	4860	2990	4490	2690	4040	2440	3670
	20	3920	5890	3640	5470	3390	5100	3140	4720	2900	4360	2610	3920	2370	3560
	22	3690	5550	3420	5140	3190	4790	2950	4430	2720	4090	2440	3670	2220	3330
	24	3460	5200	3200	4810	2980	4480	2750	4140	2540	3810	2280	3420	2060	3100
	26	3220	4840	2980	4470	2770	4160	2550	3840	2350	3530	2110	3160	1900	2860
	28	2980	4480	2750	4140	2560	3840	2360	3540	2160	3250	1940	2910	1750	2630
	30	2740	4120	2530	3800	2350	3530	2160	3240	1980	2980	1770	2660	1600	2400
	32	2510	3780	2310	3470	2140	3220	1970	2960	1800	2710	1610	2420	1450	2180
	34	2290	3440	2100	3160	1940	2920	1780	2680	1630	2450	1450	2180	1310	1960
	36	2070	3110	1900	2850	1750	2630	1600	2410	1460	2200	1300	1950	1170	1750
	38	1860	2790	1700	2560	1570	2360	1440	2160	1310	1970	1170	1750	1050	1570
	40	1680	2520	1540	2310	1420	2130	1300	1950	1180	1780	1050	1580	944	1420
42	1520	2290	1390	2090	1290	1930	1180	1770	1070	1610	954	1430	857	1290	
44	1390	2080	1270	1910	1170	1760	1070	1610	978	1470	869	1310	780	1170	
46	1270	1910	1160	1750	1070	1610	980	1470	895	1350	795	1200	714	1070	
48	1160	1750	1070	1600	984	1480	900	1350	822	1240	730	1100	656	986	
50	1070	1610	983	1480	907	1360	829	1250	758	1140	673	1010	604	908	

**Table 4.3: American Standard (ANSI/AISC 360-16) design buckling resistance [kips] of W columns in Grade 65.**

<sup>h</sup> Flange thickness is greater than 2 in. Special requirements may apply per AISC Specification Section A3.1c.

Shape		W14 x 16													
lb/ft		257		233		211		193		176		159		145	
Design		ASD	LRFD	ASD	LRFD	ASD	LRFD	ASD	LRFD	ASD	LRFD	ASD	LRFD	ASD	LRFD
Effective length, KL (ft), with respect to least radius of gyration, ry	0	2940	4420	2670	4010	2410	3630	2210	3320	2020	3030	1820	2730	1660	2500
	11	2670	4010	2420	3630	2180	3280	2000	3000	1820	2740	1640	2460	1500	2250
	12	2620	3940	2370	3560	2140	3220	1960	2950	1780	2680	1610	2420	1470	2210
	13	2570	3860	2320	3490	2100	3150	1920	2890	1750	2630	1570	2360	1440	2160
	14	2510	3780	2270	3420	2050	3080	1880	2820	1710	2570	1540	2310	1400	2110
	15	2460	3690	2220	3340	2000	3010	1830	2750	1670	2500	1500	2250	1370	2060
	16	2400	3600	2160	3250	1950	2940	1790	2680	1620	2440	1460	2190	1330	2000
	17	2330	3510	2110	3170	1900	2860	1740	2610	1580	2370	1420	2130	1290	1950
	18	2270	3410	2050	3080	1850	2780	1690	2540	1530	2300	1380	2070	1260	1890
	19	2200	3310	1990	2990	1790	2690	1640	2460	1490	2230	1330	2010	1220	1830
	20	2130	3210	1930	2890	1730	2610	1580	2380	1440	2160	1290	1940	1180	1770
	22	2000	3000	1800	2700	1620	2430	1480	2220	1340	2010	1200	1810	1090	1640
	24	1850	2790	1670	2510	1500	2250	1370	2050	1240	1860	1110	1670	1010	1520
	26	1710	2570	1540	2310	1380	2070	1260	1890	1140	1710	1020	1530	926	1390
	28	1570	2360	1410	2120	1260	1900	1150	1730	1040	1560	929	1400	844	1270
	30	1430	2150	1280	1930	1150	1720	1040	1570	940	1410	841	1270	763	1150
	32	1290	1940	1160	1740	1040	1560	940	1410	846	1270	756	1140	686	1030
	34	1160	1750	1040	1560	927	1390	841	1260	755	1140	674	1010	610	917
	36	1040	1560	927	1390	827	1240	750	1130	674	1010	601	904	544	818
	38	932	1400	832	1250	742	1120	673	1010	605	909	540	811	488	734
40	841	1260	751	1130	670	1010	607	913	546	820	487	732	441	663	
42	763	1150	681	1020	607	913	551	828	495	744	442	664	400	601	
44	695	1040	620	933	553	832	502	754	451	678	402	605	364	548	
46	636	956	568	853	506	761	459	690	412	620	368	553	333	501	
48	584	878	521	784	465	699	422	634	379	570	338	508	306	460	
50	538	809	480	722	428	644	388	584	349	525	311	468	282	424	

**Table 4.3 (continued): American Standard (ANSI/AISC 360-16) design buckling resistance [kips] of W columns in Grade 65.**

	Axis	Buckling length [m]												
		2	3	4	5	6	7	8	9	10	11	12	13	14
Box HD 400 x 634	N <sub>b,y,Rd</sub>	74 204	70653	66891	62958	58793	54402	49863	45315	40913	36791	33029	29661	26680
	N <sub>b,z,Rd</sub>	74 204	72557	69487	66346	63079	59652	56064	52348	48568	44813	41170	37715	34499
Box HD 400 x 677	N <sub>b,y,Rd</sub>	79 291	77676	71647	67498	63109	58480	53688	48873	44196	39799	35773	32157	28948
	N <sub>b,z,Rd</sub>	79 291	75620	74446	71145	67720	64129	60370	56471	52497	48533	44671	40993	37554
Box HD 400 x 744	N <sub>b,y,Rd</sub>	85178	81587	77451	73146	68603	63811	58832	53793	48855	44165	39829	35902	32393
	N <sub>b,z,Rd</sub>	85178	83767	80409	76990	73450	69748	65875	61851	57729	53584	49521	45609	41920
Box HD 400 x 818	N <sub>b,y,Rd</sub>	93706	90006	85548	80920	76043	70900	65545	60105	54740	49613	44844	40499	36598
	N <sub>b,z,Rd</sub>	93706	92414	88808	85146	81363	77415	73287	68992	64581	60130	55729	51469	47424
Box HD 400 x 900	N <sub>b,y,Rd</sub>	103232	99424	94614	89629	84385	78857	73093	67213	61384	55779	50532	45724	41386
	N <sub>b,z,Rd</sub>	103232	102099	98225	94300	90255	86042	81641	77059	72341	67558	62803	58169	53738
Box HD 400 x 990	N <sub>b,y,Rd</sub>	113385	109542	104380	99046	93446	87546	81384	75074	68783	62690	56945	51645	46836
	N <sub>b,z,Rd</sub>	113385	112462	108314	104121	99810	95331	90656	85788	80764	75652	70541	65527	60700
Box HD 400 x 1086	N <sub>b,y,Rd</sub>	124529	120647	115100	109381	103390	97082	90487	83712	76923	70305	64023	58193	52872
	N <sub>b,z,Rd</sub>	124529	123878	119443	114970	110384	105629	100673	95513	90178	84729	79253	73847	68605
Box HD 400 x 1202	N <sub>b,y,Rd</sub>	137443	133346	127291	121056	114530	107663	100480	93090	85665	78408	71494	65056	59165
	N <sub>b,z,Rd</sub>	137443	137162	132412	127633	122746	117693	112435	106963	101297	95491	89624	83795	78099
Box HD 400 x 1299	N <sub>b,y,Rd</sub>	148230	144267	137898	131358	124528	117350	109837	102084	94254	86547	79151	72214	65824
	N <sub>b,z,Rd</sub>	148230	148230	143333	138320	133207	127930	122449	116749	110842	104775	98620	92471	86427

**Table 4.4: Eurocode (EN 1993-1-1: 2005) design buckling resistance [kN] of strong and weak axis of HD Box columns sections in HISTAR® 460.**

	Axis	Buckling length [m]												
		2	3	4	5	6	7	8	9	10	11	12	13	14
Cruciform HL 1100 x 607	N <sub>b,y,Rd</sub>	71039	71039	71039	70020	68374	66721	65046	63342	61598	59807	57967	56077	54139
	N <sub>b,z,Rd</sub>	71039	71039	71039	70221	68615	67004	65375	63719	62027	60292	58511	56682	54806
Cruciform HL 1000 x 642	N <sub>b,y,Rd</sub>	75125	75125	75125	73441	71578	69699	67788	65835	63828	61762	59635	57450	55214
	N <sub>b,z,Rd</sub>	75125	75125	75125	73708	71899	70078	68229	66343	64408	62419	60373	58270	56116
Cruciform HL 920 x 656	N <sub>b,y,Rd</sub>	76752	76752	76752	74586	72590	70571	68513	66402	64227	61986	59677	57306	54887
	N <sub>b,z,Rd</sub>	76752	76752	76752	74891	72958	71008	69022	66991	64901	62750	60534	58258	55931
Cruciform HL 920 x 725	N <sub>b,y,Rd</sub>	84801	84801	84801	82472	80280	78064	75805	73489	71105	68647	66116	63517	60863
	N <sub>b,z,Rd</sub>	84801	84801	84801	82846	80731	78598	76429	74210	71929	69581	67164	64681	62141
Cruciform HL 1000 x 748	N <sub>b,y,Rd</sub>	87605	87605	87605	85771	83624	81461	79264	77019	74713	72342	69901	67393	64826
	N <sub>b,z,Rd</sub>	87605	87605	87605	86129	84054	81969	79854	77698	75489	73220	70886	68488	66031
Cruciform HL 920 x 787	N <sub>b,y,Rd</sub>	92071	92071	92071	89638	87278	84893	82464	79975	77413	74773	72054	69262	66410
	N <sub>b,z,Rd</sub>	92071	92071	92071	90069	87798	85508	83181	80803	78360	75846	73258	70600	67878
Cruciform HL 1000 x 883	N <sub>b,y,Rd</sub>	103402	103402	103402	101400	98899	96381	93826	91216	88540	85787	82955	80045	77065
	N <sub>b,z,Rd</sub>	103402	103402	103402	101891	99489	97076	94634	92146	89599	86986	84299	81540	78711
Cruciform HL 920 x 970	N <sub>b,y,Rd</sub>	111159	111159	111159	108615	105847	103055	100215	97311	94327	91255	88092	84843	81519
	N <sub>b,z,Rd</sub>	111159	111159	111159	109238	106597	103940	101246	98498	95683	92790	89814	86757	83625
Cruciform HL 1000 x 976	N <sub>b,y,Rd</sub>	111735	111735	111735	109818	107165	104498	101793	99035	96208	93304	90317	87248	84104
	N <sub>b,z,Rd</sub>	111735	111735	111735	110389	107851	105305	102730	100111	97434	94689	91870	88975	86007
Cruciform HL 920 x 1077	N <sub>b,y,Rd</sub>	123331	123331	123331	120665	117625	114562	111448	108266	104997	101634	98172	94616	90975
	N <sub>b,z,Rd</sub>	123331	123331	123331	121410	118522	115618	112677	109681	106612	103461	100222	96894	93483
Cruciform HL 920 x 1194	N <sub>b,y,Rd</sub>	136816	136816	136816	134043	130710	127351	123940	120457	116881	113204	109419	105531	101549
	N <sub>b,z,Rd</sub>	136816	136816	136816	134941	131789	128622	125418	122156	118819	115395	111878	108264	104559
Cruciform HL 920 x 1269	N <sub>b,y,Rd</sub>	145357	145357	145357	142531	139014	135471	131876	128205	124438	120566	116581	112487	108294
	N <sub>b,z,Rd</sub>	145357	145357	145357	143525	140208	136878	133510	130084	126580	122987	119297	115506	111620
Cruciform HL 920 x 1377	N <sub>b,y,Rd</sub>	157652	157652	157652	154264	150383	146471	142495	138432	134260	129966	125547	121007	116359
	N <sub>b,z,Rd</sub>	157652	157652	157652	155601	151990	148364	144697	140965	137148	133233	129211	125080	120845

**Table 4.5: Eurocode (EN 1993-1-1: 2005) design buckling resistance [kN] of strong and weak axis of Cruciform sections in HISTAR® 460.**



	Axis	Buckling length [m]												
		2	3	4	5	6	7	8	9	10	11	12	13	14
Box W 360 x 410 x 634	N <sub>b,y,Rd</sub>	64259	62945	61150	58917	56299	53354	50147	46745	43215	39623	36030	32494	29063
	N <sub>b,z,Rd</sub>	63684	63684	62432	60859	58990	56855	54488	51923	49200	46356	43429	40457	37475
Box W 360 x 410 x 677	N <sub>b,y,Rd</sub>	68691	67315	65435	63094	60347	57254	53882	50299	46576	42781	38979	35228	31581
	N <sub>b,z,Rd</sub>	68104	68104	66805	65170	63227	61004	58537	55861	53015	50038	46968	43845	40705
Box W 360 x 410 x 744	N <sub>b,y,Rd</sub>	75469	74008	72010	69521	66595	63295	59690	55852	51854	47767	43660	39595	35628
	N <sub>b,z,Rd</sub>	74858	74858	73487	71761	69706	67354	64738	61896	58867	55691	52410	49061	45685
Box W 360 x 410 x 818	N <sub>b,y,Rd</sub>	83100	81550	79428	76781	73664	70144	66291	62180	57885	53483	49045	44638	40321
	N <sub>b,z,Rd</sub>	82471	82471	81030	79213	77049	74567	71802	68793	65578	62199	58699	55116	51493
Box W 360 x 410 x 900	N <sub>b,y,Rd</sub>	91586	89940	87685	84868	81548	77792	73672	69265	64652	59910	55114	50335	45639
	N <sub>b,z,Rd</sub>	90942	90942	89429	87520	85243	82628	79710	76527	73120	69531	65802	61974	58091
Box W 360 x 410 x 990	N <sub>b,y,Rd</sub>	100672	98939	96562	93589	90080	86103	81731	77044	72122	67048	61899	56750	51669
	N <sub>b,z,Rd</sub>	100009	100009	98426	96428	94041	91296	88229	84876	81280	77482	73526	69454	65310
Box W 360 x 410 x 1086	N <sub>b,y,Rd</sub>	110572	108744	106236	103096	99383	95168	90526	85538	80288	74859	69333	63789	58298
	N <sub>b,z,Rd</sub>	109901	109901	108253	106171	103680	100811	97599	94083	90303	86301	82122	77808	73403
Box W 360 x 410 x 1202	N <sub>b,y,Rd</sub>	122094	120116	117401	114000	109977	105405	100365	94944	89231	83316	77286	71226	65214
	N <sub>b,z,Rd</sub>	121458	121458	119742	117572	114972	111975	108613	104924	100950	96732	92315	87741	83057
Box W 360 x 410 x 1299	N <sub>b,y,Rd</sub>	132150	130102	127287	123757	119576	114816	109559	103891	97903	91685	85327	78915	72531
	N <sub>b,z,Rd</sub>	131503	131503	129734	127495	124810	121711	118230	114405	110276	105886	101278	96496	91585

Table 4.6: American Standard (ANSI/AISC 360-16) design buckling resistance [kN] of W Box columns in Grade 65.

	Axis	Buckling length [m]												
		2	3	4	5	6	7	8	9	10	11	12	13	14
Cruciform W 1100 x 400 x 607	N <sub>b,y,Rd</sub>	62322	62044	61656	61161	60562	59861	59062	58170	57189	56127	57189	56127	57189
	N <sub>b,z,Rd</sub>	62333	62068	61699	61227	60656	59988	59226	58374	57436	56417	57436	56417	57436
Cruciform W 1000 x 400 x 642	N <sub>b,y,Rd</sub>	65873	65536	65068	65536	65068	65536	65068	65536	65068	65536	65068	65536	65068
	N <sub>b,z,Rd</sub>	65888	65571	65129	65571	65129	65571	65129	65571	65129	65571	65129	65571	65129
Cruciform W 920 x 420 x 656	N <sub>b,y,Rd</sub>	67273	66897	66373	65706	66373	65706	66373	65706	66373	65706	66373	65706	66373
	N <sub>b,z,Rd</sub>	67291	66937	66445	65817	66445	65817	66445	65817	66445	65817	66445	65817	66445
Cruciform W 920 x 420 x 725	N <sub>b,y,Rd</sub>	74332	73921	73349	72620	73349	72620	73349	72620	73349	72620	73349	72620	73349
	N <sub>b,z,Rd</sub>	74354	73971	73437	72756	73437	72756	73437	72756	73437	72756	73437	72756	73437
Cruciform W 1000 x 400 x 748	N <sub>b,y,Rd</sub>	76823	76440	75907	76440	75907	76440	75907	76440	75907	76440	75907	76440	75907
	N <sub>b,z,Rd</sub>	76843	76485	75986	76485	75986	76485	75986	76485	75986	76485	75986	76485	75986
Cruciform W 920 x 420 x 787	N <sub>b,y,Rd</sub>	80710	80270	79659	78880	79659	78880	79659	78880	79659	78880	79659	78880	79659
	N <sub>b,z,Rd</sub>	80735	80327	79759	79035	79759	79035	79759	79035	79759	79035	79759	79035	79759
Cruciform W 1000 x 400 x 883	N <sub>b,y,Rd</sub>	90685	90244	89631	90244	89631	90244	89631	90244	89631	90244	89631	90244	89631
	N <sub>b,z,Rd</sub>	90712	90305	89738	90305	89738	90305	89738	90305	89738	90305	89738	90305	89738
Cruciform W 920 x 420 x 970	N <sub>b,y,Rd</sub>	99622	99098	98369	97439	98369	97439	98369	97439	98369	97439	98369	97439	98369
	N <sub>b,z,Rd</sub>	99659	99181	98515	97666	98515	97666	98515	97666	98515	97666	98515	97666	98515
Cruciform W 1000 x 400 x 976	N <sub>b,y,Rd</sub>	100177	99697	99029	99697	99029	99697	99029	99697	99029	99697	99029	99697	99029
	N <sub>b,z,Rd</sub>	100209	99769	99157	99769	99157	99769	99157	99769	99157	99769	99157	99769	99157
Cruciform W 920 x 420 x 1077	N <sub>b,y,Rd</sub>	110541	109971	109178	108167	109178	108167	109178	108167	109178	108167	109178	108167	109178
	N <sub>b,z,Rd</sub>	110585	110069	109351	108435	109351	108435	109351	108435	109351	108435	109351	108435	109351
Cruciform W 920 x 420 x 1194	N <sub>b,y,Rd</sub>	122638	122020	121159	120062	121159	120062	121159	120062	121159	120062	121159	120062	121159
	N <sub>b,z,Rd</sub>	122690	122136	121365	120380	121365	120380	121365	120380	121365	120380	121365	120380	121365
Cruciform W 920 x 420 x 1269	N <sub>b,y,Rd</sub>	130301	129653	128751	127600	128751	127600	128751	127600	128751	127600	128751	127600	128751
	N <sub>b,z,Rd</sub>	130358	129781	128977	127950	128977	127950	128977	127950	128977	127950	128977	127950	128977
Cruciform W 920 x 420 x 1377	N <sub>b,y,Rd</sub>	141304	140577	139565	138275	139565	138275	139565	138275	139565	138275	139565	138275	139565
	N <sub>b,z,Rd</sub>	141381	140751	139872	138751	139872	138751	139872	138751	139872	138751	139872	138751	139872

Table 4.7: American Standard (ANSI/AISC 360-16) design buckling resistance [kN] of cruciform columns in Grade 65.



© Dario Trabucco / CTBUH

### • Megacolumns

Megacolumns are composed of more than one structural steel wide flange shape with longitudinal rebar and ties embedded in concrete. These are a convenient solution in terms of structural behaviour, cost and constructability for the design of tall buildings (incl. towers over 300m). They serve to support gravity loads, as well as axial loads from wind and seismic overturning, and the reinforced concrete surrounding the megacolumns is not only for structural stability, but also protects the steel column from corrosion and fire.

High-rise buildings have been built in recent years all around the world and most of their structures are made using reinforced concrete as the core and structural steel as the surrounding frame.

Minimising the size of the vertical structural elements, without compromising the economic feasibility of projects and limiting their impact on tall buildings' floor plans, is a constant challenge. The use of composite structural elements combining high grade concrete and steel is a viable solution.

Currently, concrete filled tubes (CFT) or concrete filled continuous caissons built-up by welding heavy plates are common structural solutions. Their main drawbacks include high costs, the need for skilled labour, complex connections, and requiring welding conditions for heavy plates, such as preheating and repairing.

This technical solution brings several advantages:

- smaller footprint of the column
- lower prices thanks to the simplicity of the system itself
- safe and reliable (i.e. minimal welding is necessary on site and, fire protection can be achieved utilising the surrounding concrete)
- construction times are decreased dramatically due to off-site fabrication and faster erection
- optimisation of the section using composite action decreases significantly the environmental footprint of the structural system.

### • Experimental Testing of Composite Megacolumns

Experimental performance tests on composite megacolumns with encased hot rolled steel sections supported and founded by ArcelorMittal, were carried out between February and September 2015 at the China Academy of Building Research Technologies (CABR) Laboratories and the Laboratories of Tsinghua University, Beijing.

The design office, Magnusson Klemencic Associates, provided background studies on comparative composite megacolumn construction projects, both within China and other international markets and the Council on Tall Buildings and Urban Habitat (CTBUH) assumed the role of project coordinator.



© Dario Trabucco / CTBUH

**Figure 4.11 Mega-Column scaled (1:4) Specimen tested to failure**

The composite megacolumns considered in this testing were defined as vertical structural systems with four hot-rolled steel sections embedded in concrete and subjected to significant vertical loads and secondary bending moments from wind and seismic actions.

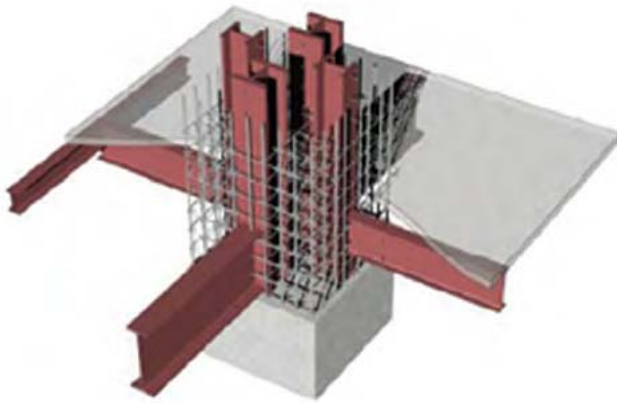

Although codes and specifications do consider composite structural elements, they do not offer specific provisions on the design of composite sections with two or more encased steel sections (American Institute of Steel Construction AISC 2010 Specifications for instance). The lack of knowledge on the axial, bending and shear behaviour of composite megacolumns, along with the resulting lack of clarity in the codes, is what led to the need for experimental performance tests.

The column specimens' overall layout and geometry were based on suggestions from Magnusson Klemencic Associates and others, with the goal to be representative of full scale composite columns considered for high-rise buildings. Overall dimensions of the representative full-scale columns considered for this testing program are 1800 x 1800mm, with a height of 9m at the lobby level (base of the tower) and 4,5m at the typical floor.



**Figure 4.13: Scaled (1:6) Specimen tested to failure**

The experimental campaign consisted of two sets of tests that attempt to define the axial load and moment (P-M) interaction curves of the representative columns at failure. Static tests were accomplished by applying 0%, 10% and 15% eccentricity axial loads, on six 1:4 scaled specimens, until failure (Figure 4.11). Quasi-static tests were accomplished by applying 10% and 15% eccentricity axial loads with horizontal forces on four 1:6 scaled specimens, until failure (Figure 4.13).

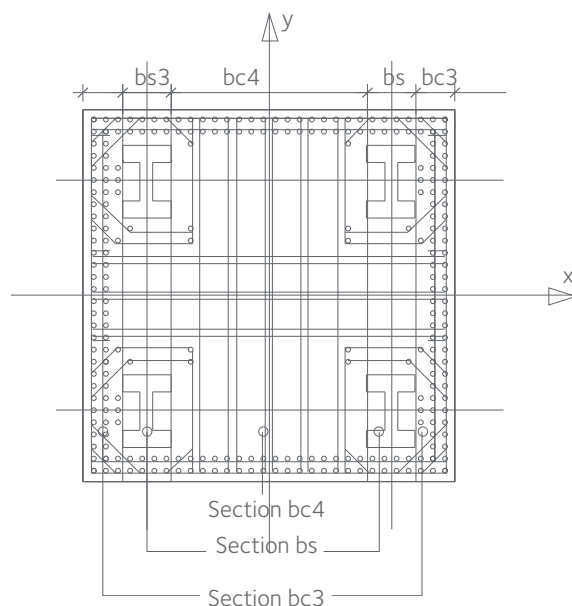

**Figure 4.12: Section layout of reinforcement Example of the Eurocode 4 Design Method**

The results of the tests were used to investigate the specimens' maximum capacity, displacements, stress distribution, ductility and stiffness. The experimental results were further validated by the finite element method (FEM) models developed by CABR and ArcelorMittal with Abaqus and Safir software. FEM models also allow for a deeper insight on steel-concrete interaction forces and stress distribution.

• **Design rules**

Subsequently, simplified design methods based on European, Chinese and US codes were suggested, and the results compared to numerical and experimental values. This proved the simplified structural design methods to be an effective and useful design tool.

A complete description of the research programme, design methods, design examples including all information and data of the experimental campaign can be found at [sections.arcelormittal.com](http://sections.arcelormittal.com) or at [ctbuh.org/Research Reports](http://ctbuh.org/Research Reports).



Figure 4.12:  
pre-design  
softwares available on  
sections.arcelormittal.com

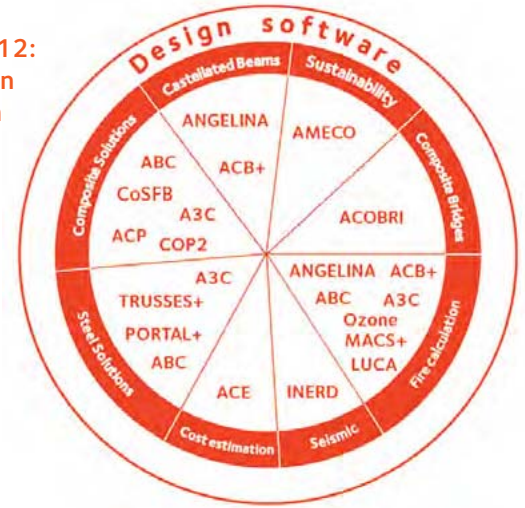

• **Predesign tools, software**

A3C – Verification of steel and composite (partially or totally encased) columns in cold and fire conditions

A3C: This software is available for free at [sections.arcelormittal.com](http://sections.arcelormittal.com) in the "Design aid" menu: Design Software. The A3C software allows the designer to perform a detailed verification of a single steel member or a composite steel–concrete column (partially encased, fully encased in concrete or in a concrete filled tube) subjected to axial force and/or bending moments according to the rules of the Eurocodes.

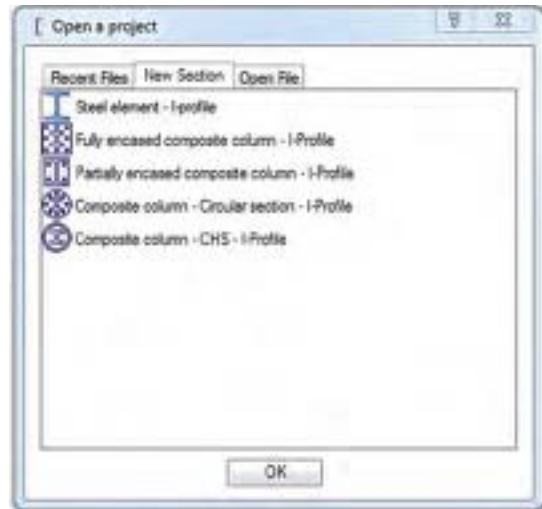
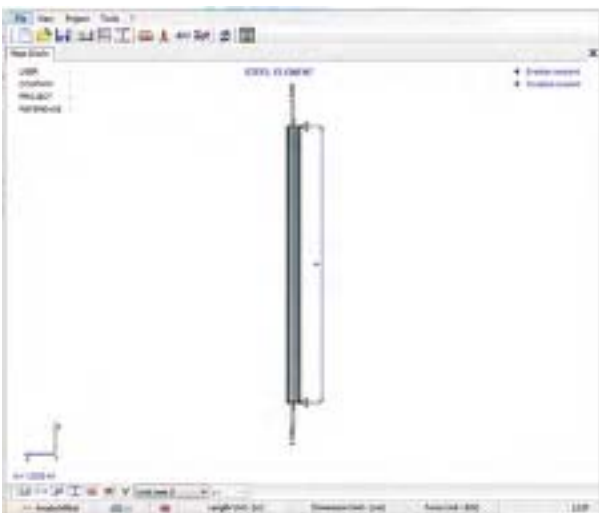

Above, an example of a 6m column under a design axial load of 29000kN is shown. A3C software can define the loads, their combinations as well as the other design parameters such as the fire resistance, the steel sections (i.e. HD 400 x 634) and their steel grade (i.e. HISTAR® 460). With a single click, a resistance check can be performed (see below), additionally the fire protection thickness can also be provided.

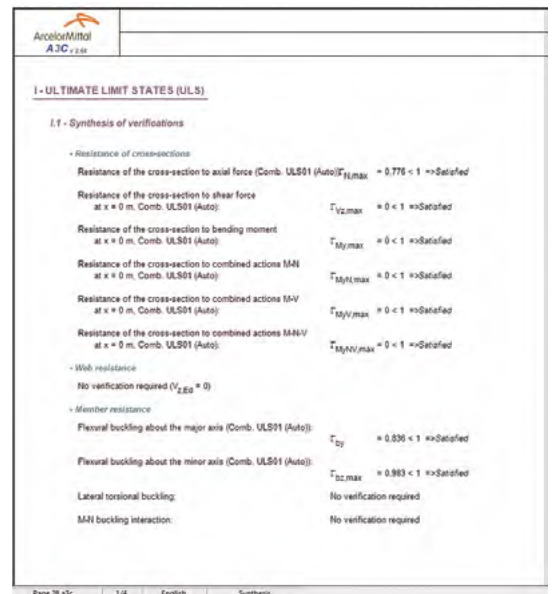
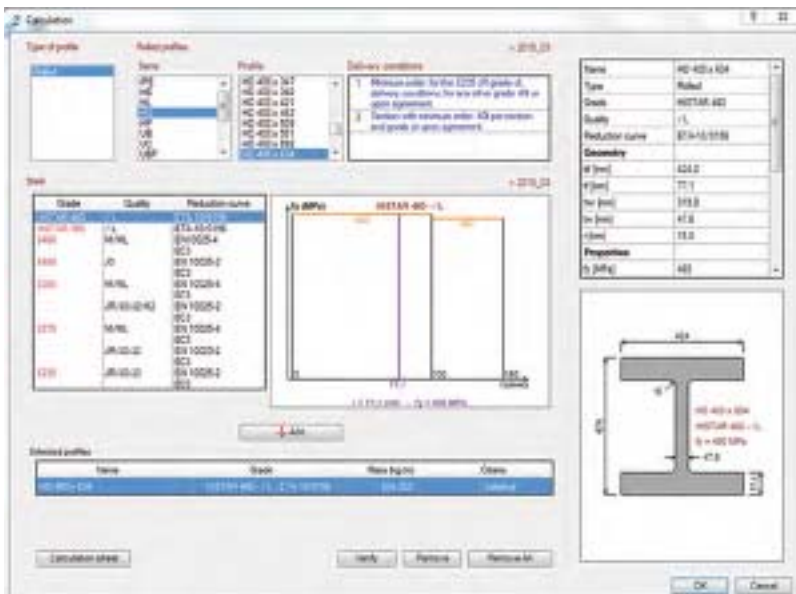





## 5. Bracing systems

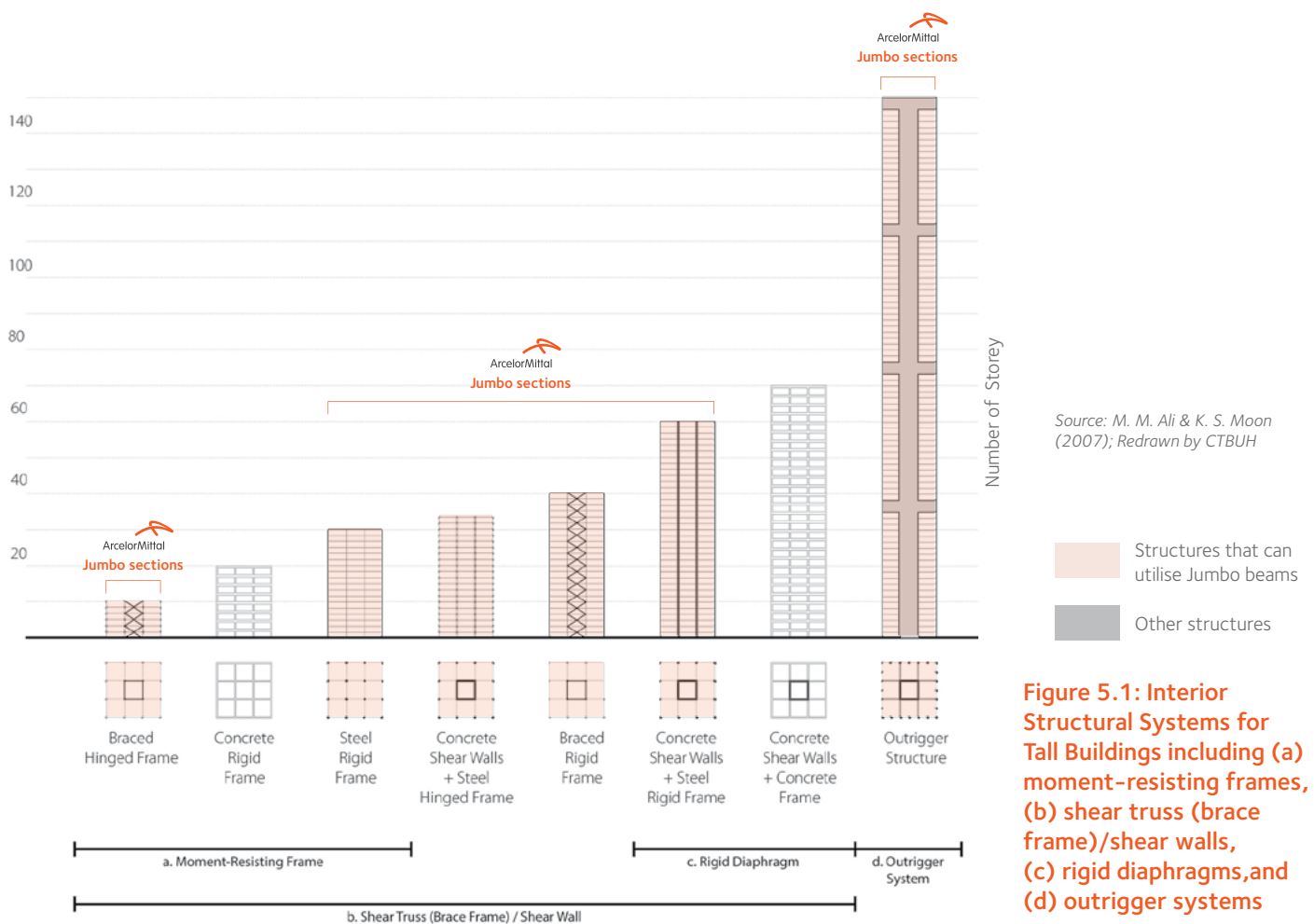

### • Structural Systems for Tall Buildings

As height and slenderness of buildings increase, lateral drifts start to control the design of the structure and the stiffness of the components become the dominant factor instead of their strength. Therefore, the need for appropriate structural systems, beyond the simple rigid frame, must be properly addressed in the design of tall buildings, accounting for the prominent loads and forces that differ depending on a building's height.

Lateral forces are usually the driving parameter for the design of a tall building's structural system, and strength, stiffness and damping are the main parameters controlling the limiting factors of displacements (e.g. Building Height/250) and accelerations (e.g. 18 milli-g per 10-year wind return period). Therefore, the ideal structure to withstand the effects of bending, shear and vibrations is a system in which the vertical elements are located at the farthest extremity from the

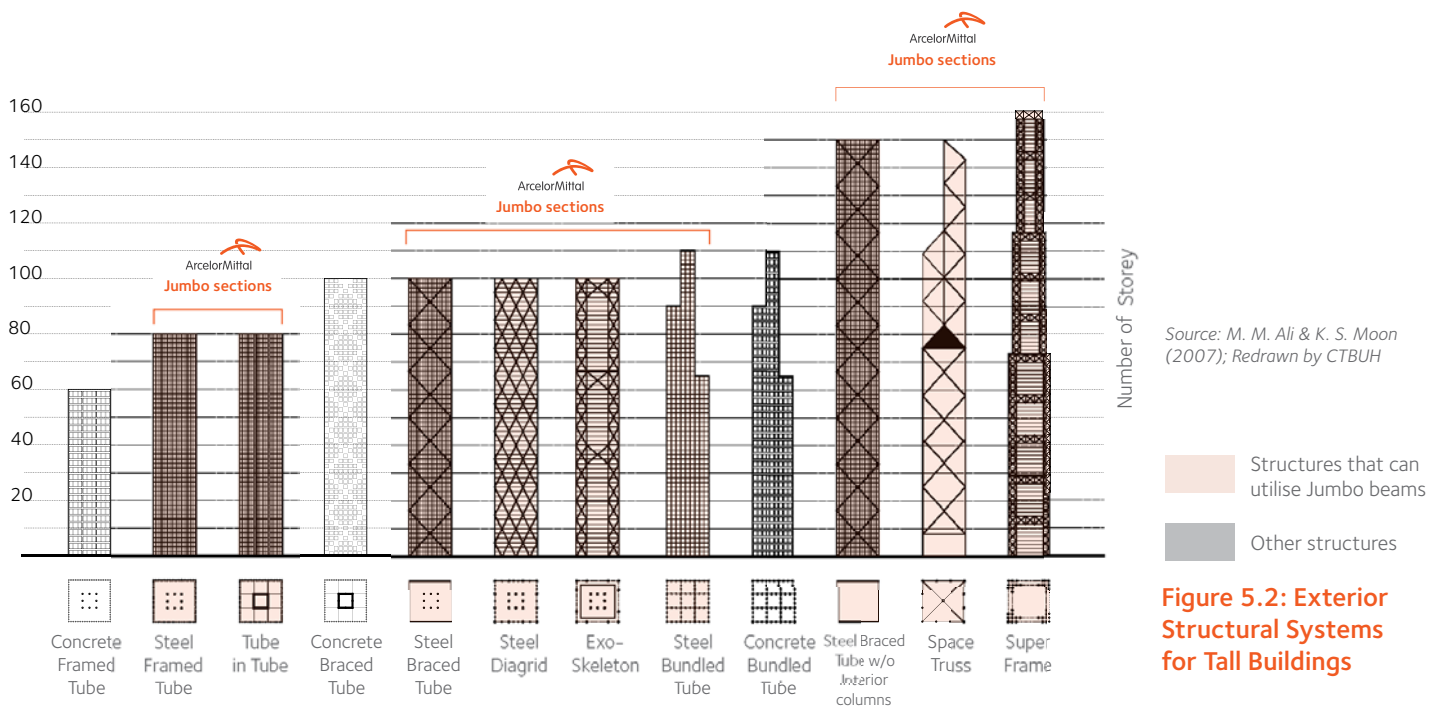

Source: M. M. Ali & K. S. Moon (2007); Redrawn by CTBUH

**Figure 5.2: Exterior Structural Systems for Tall Buildings**

geometric center of the building, such as in a hollow tube. Here, the parameters that control the efficiency of the structural element's layout are bending and shear rigidity. From the bending rigidity standpoints, the best solution would be to maximise the total moment of inertia of the overall structure, positioning columns at the corners along the outermost perimeter of the building. As far as shear efficiency is concerned, the ideal solution would be a continuous wall without openings.

The existing structural systems used in contemporary tall buildings stem from the basic principles described above. During the last 50 years, rigid frame systems adopted in older tall buildings evolved into different structural families that are used depending on a number of parameters including the size of the building, the magnitude of the external forces, the availability and cost of materials, and labour and stylistic decisions made by the architect and the developer. A common classification of tall buildings structural systems was given by Ali and Moon [2007]\* that propose two main categories: interior (Figure 5.1) and exterior (Figure 5.2) (depending if the main lateral resisting system is at the perimeter or not). Each system has a wide variety of application height that depends on several factors (e.g. building stability, aspect ratio (height/width), architectural functions, etc.).

Interior structures (Figure 5.1) are composed of two main systems: moment-resisting frames (Figure 5.1a) and shear truss (braced frame)/shear wall (Figure 5.1b). These systems alone can provide resistance up to 30 storeys, since higher buildings would require deeper elements that are not architecturally and economically feasible. An alternative system is to combine rigid frames with shear truss/shear wall through a rigid diaphragm (Figure 5.1c) and this could lead to buildings up to 70 storeys. The different sway behaviour of the two systems permit the movement to be constrained, making the whole system more rigid (Figure 5.3).

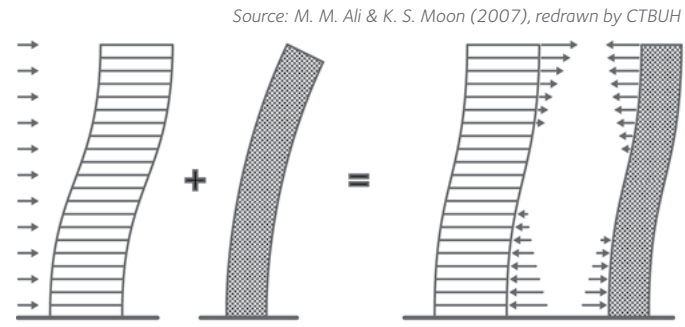

Source: M. M. Ali & K. S. Moon (2007), redrawn by CTBUH

**Figure 5.3: Shear Wall-Rigid Frame Interaction**

Another alternative solution, becoming popular today for super tall buildings, is the so-called outrigger system (Figure 5.1d) that can reach up to 150 storeys or more. The major benefits are to reduce the core overturning moment, storey drifts and floor accelerations (i.e. increasing building comfort). The basis of this structural system is that the overturning moment resistance of the building core is countered through coupling of the compression-tension of the external columns through the help of stiff headers (steel trusses or shear walls, Figure 5.4). This increases the structure flexural rigidity without enhancing the shear rigidity. This system is becoming less efficient if utilised for tube in tube dual systems since the

Source: Taranath (1998) Redrawn by CTBUH

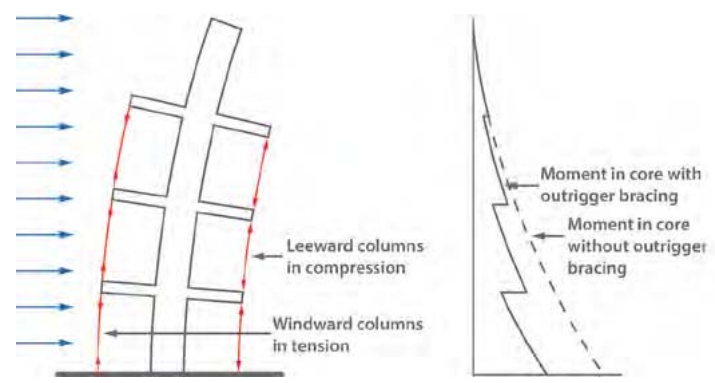

**Figure 5.4: Outrigger structural system principles**



Figure 5.5: New York Times Tower, New York City, USA

## OUTRIGGER / BELT TRUSS LEVELS

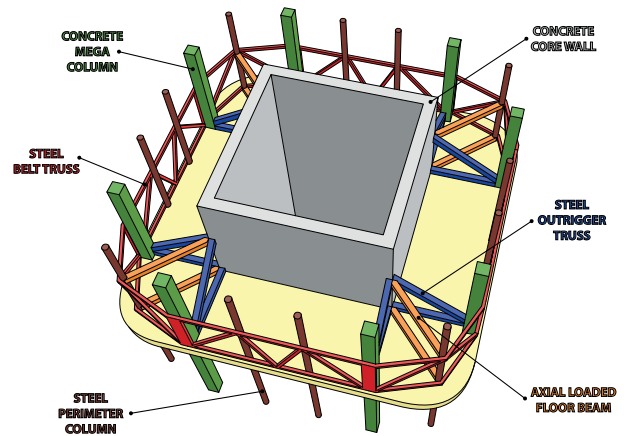

Figure 5.7: Outriggers trusses and belt trusses

lateral response of the two systems is very similar. Outrigger performance is a function of the location through the building height, the presence of belt trusses (to help engaging perimeter columns) or single megacolumns and their structural depth. One of the major issues of outriggers is the differential deformation of core and columns that can create additional forces in the outriggers. For this reason, an alternative solution could be belt trusses in conjunction with rigid diaphragms.

Exterior structures (Figure 5.2) are based on the typical tube structure in which the whole perimeter is designed to resist the lateral loads. This structural system has shear lag problems in which corner columns have larger axial forces due to the intrinsic nature of the system (Figure 5.6), in which shear is carried through columns and beams bending. To overcome these problems different structural solutions have been adopted: braced tube, bundle tube, tube-in-tube systems and diagrids. Particularly, diagrid systems are considered advantageous since they provide both shear and bending rigidity to the building. Alternative solutions, in the exterior category are: space trusses, super frames and exoskeletons.

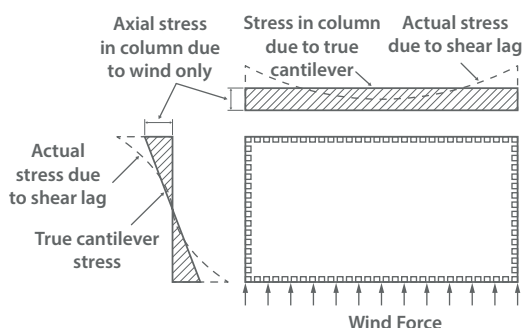
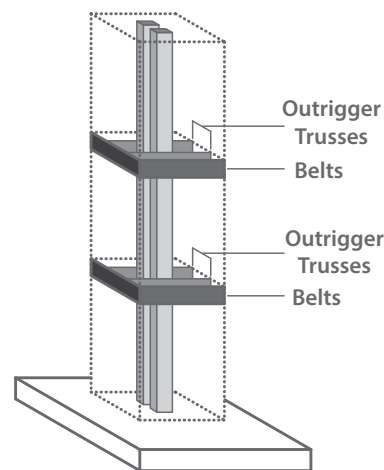

Figure 5.6: Shear lag principles

### • Outriggers and Belt Trusses (Figure 5.7)

Outriggers connect the core to the outer columns through a rigid system (e.g. truss). In addition, at the same outrigger level belt trusses can be utilised to distribute the axial forces in the exterior frames and to provide additional torsional resistance (Figure 5.8). Moreover, belt trusses are efficient in differential elongation and shortening of columns. A gain of 25-30% stiffness can be achieved by combining belt trusses and outriggers trusses, as well as a column-free space leading to an increasing functional efficiency of the building.



Source: Khanorkar et al. (2016)  
Redrawn by CTBUH

Figure 5.8  
Outrigger and belt trusses location scheme in a tall building

The design principles of outriggers, virtual outriggers and belt trusses are based on the conversion of the core overturning moment into a couple of horizontal forces and then into axial forces in the exterior columns (Figure 5.9). Additional information can be found in the CTBUH Technical Guide "Outrigger Design for High-Rise Buildings" (see p.29).

Figure 5.9:  
Force transfer using an outrigger system

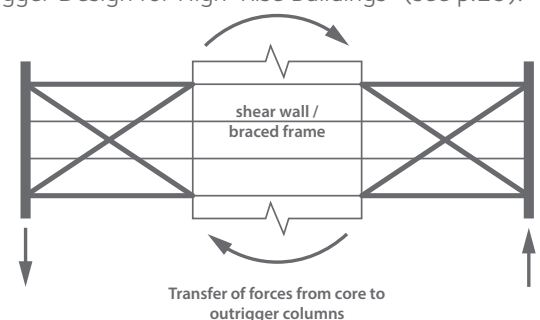

### • Trusses

A truss is essentially a triangulated system of straight interconnected structural elements and they are utilised to increase the lateral stiffness. In high-rise buildings, trusses serve as bracing systems (e.g. belt truss and outriggers) as well as super floors.





© (CC BY-SA) MusikAnimal

© Magnusson Klemencic Associates



Figure 5.10: 300 North LaSalle, Chicago, USA

The major benefits of this outrigger-belt truss system are:

- deformation reduction due to increased stiffness
- efficiency in structural usage, lower demands in the core with uniform exterior columns utilisation
- reduction in foundation forces underneath the core
- enhanced torsional stiffness due to belt truss
- enhanced progressive collapse resistance due to the presence of an alternative load path
- architectural flexibility since it permits wide spaced perimeter columns and lower spandrel beam depth.

Instead, the major shortcomings are:

- differential deformation between core and columns that can create additional forces in the outriggers. For this reason, an alternative solution can be belt trusses in conjunction with rigid diaphragms ("Virtual" outriggers (Figure 5.11) [Nair, 1998]\*).
- usability of occupied spaces since outriggers interfere with the space usage at the floor they are allocated. In alternative, outriggers can be allocated in mechanical floors or they can serve as super floors for safety and evacuation purposes.
- floor diaphragms stiffness is important since it allows transferring the forces from the core to the exterior column. This is particular relevant for the "virtual" outrigger system (Figure 5.11).
- foundation dishing due to core and perimeter column differential settlement
- change in stiffness between outrigger and adjacent storeys. This can create a sort of "soft" storey behaviour.

Figure 5.11: Force transfer using a belt truss and a virtual outrigger

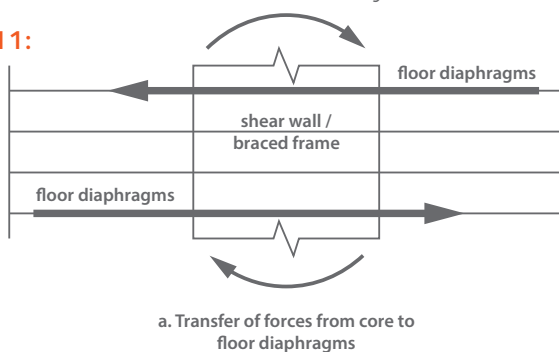

• Super Floors

There are ideal locations for outriggers and belt trusses but realities of space planning to suit architectural, mechanical and leasing criteria leave such consideration to be purely academic. Then outriggers are located typically to some of the mechanical or refuge floors (i.e. super floors), which are composed of belt trusses and located at regular intervals in the building. Super floors serve also as alternative load path in case of building partial collapse and therefore increase building robustness.

• Connections

Care needs to be considered for the outrigger and belt connection since they need to transfer high loads between the core and the exterior columns. There are mainly two

Source: Choi et al. (2016); Redrawn by CTBUH

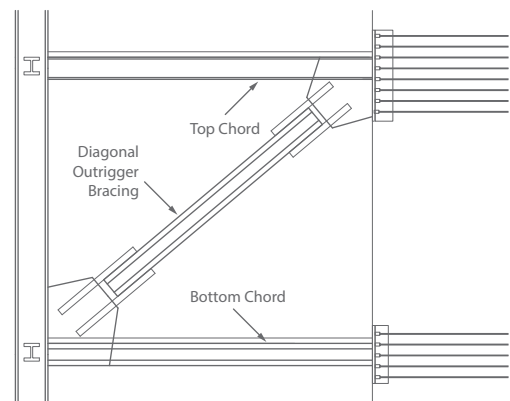
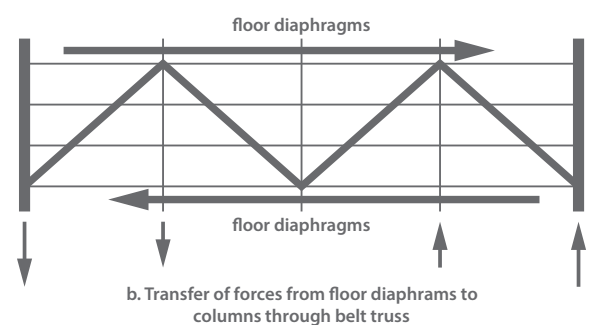

Figure 5.12: Outrigger connection with embedded plates and bar anchors [Choi, 2012] \*\*





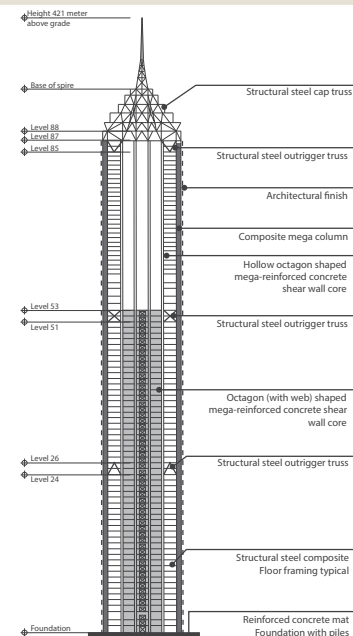

Figure 5.13: Jin Mao Tower, Shanghai, China

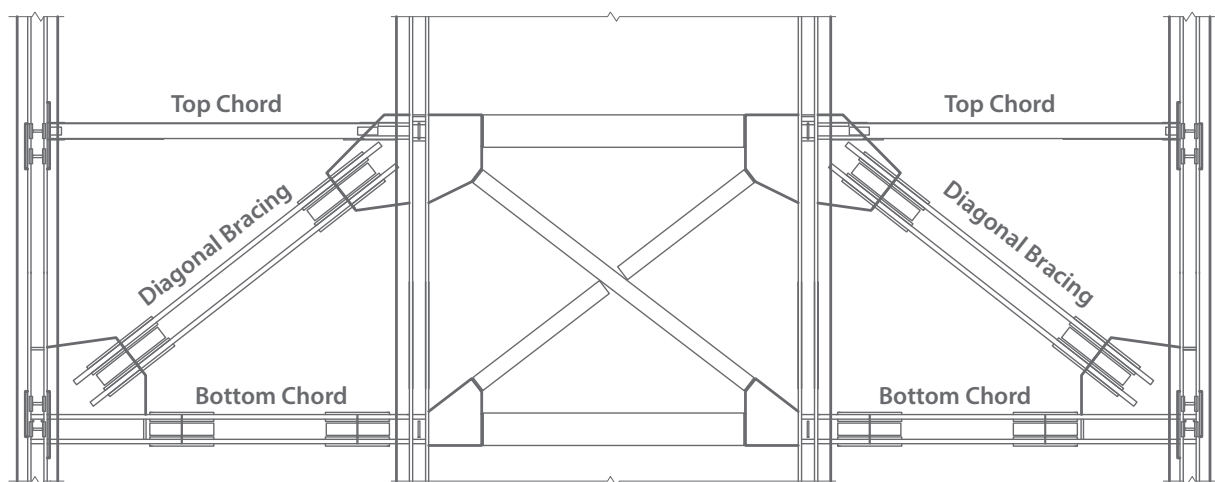

Figure 5.14: Outrigger connections with continuous steel members [Choi, 2012]\*\*

possible connections: continuous steel members (Figure 5.14) and steel to concrete with embedded plates and anchors (Figure 5.12).

#### • Steel Profiles

Outriggers and belt trusses require large member sizes due to the high axial load. This is caused by the large portion of the building overturning that they need to resist, since they are provided only in few locations throughout the building height. Therefore, ArcelorMittal Jumbo profiles are ideal for such applications. HISTAR®/ASTM A913 steels develop their full potential in the design of tension members in trusses. Here, they allow saving material costs by taking full advantage of the high yield strength and, therefore, also thinner sections and smaller welds, which leads to savings in fabrication costs. Using HISTAR® 460 in truss design will result in direct tonnage savings. Truss compression and tension members will achieve 20–25% weight savings (Figure 5.15).

#### • Wind Design

Many aspects should be carefully considered when addressing lateral loads, especially in the case of wind: strength and stability, excessive lateral deflections, frequency

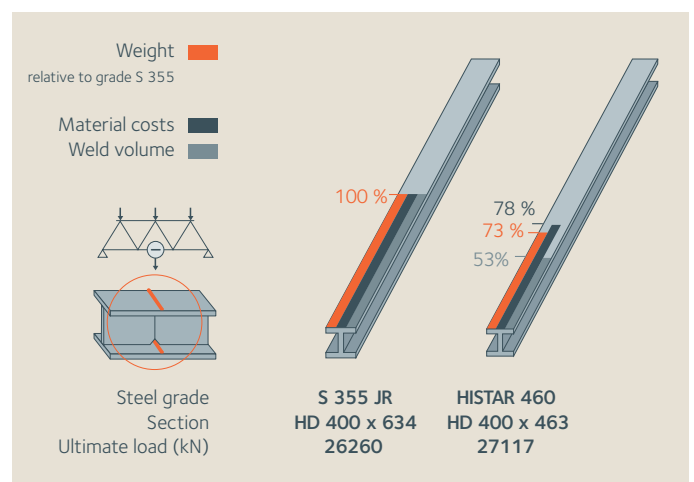

Figure 5.15: HISTAR® in trusses

and amplitude of sway (the resonance of building motions can create problems with an elevator's hoist rope). Additionally, wind can also affect the surroundings of a building. There can be wind acceleration nearby or annoying acoustic disturbances that can be heard from far distances. Overall, it is necessary to consider wind loads when determining the required strength and stiffness of building frames.

\*\*Choi, H.S., Ho, G., Joseph, L., and Mathias, N., 2012. Outrigger Design for High-Rise Buildings: An Output of the CTBUH Outrigger Working Group. Council of Tall Buildings and Urban Habitat: Chicago.



Figure 5.16: Shanghai tower, Shanghai, China

The effect of wind on a building can be described as two mechanisms: buffeting and vortex-shedding. The buffeting component acts in the along-wind direction and it can be easily estimated from code approaches. The vortex-shedding component acts mainly in perpendicular direction to the downstream flow and it is less predictable since it induces dynamic loads that are a function of the building forms and relative surrounding. Therefore, in addition to a building's superstructure, information on local wind conditions is required in order to determine the necessary strength and stiffness of wall elements, roof elements and their fastenings. Particularly, for tall buildings one of the critical design aspects is the resonant behaviour to vortex-shedding excitation. This is usually related to vortex-shedding with return periods of 50-100 years that refers to ultimate limit states design wind loads. However, for super tall and slender buildings, this resonant effect is more related to serviceability performance of building that has a critical design return periods between 1-10 years [ASCE, 2015]\*. This induces problems with occupancy comfort rather than strength design.

• Seismic Design

Looking at the seismic design of superstructures, as their degree-of-freedom increases, there is a higher number of significant modes to be taken into consideration and the response to seismic excitement becomes more complex. Tall buildings appear to be more flexible than low-rise buildings and thus generally experience lower accelerations (despite bigger displacements demands). On the other hand, when the attenuation of seismic waves is considered, long-period components are not attenuated as fast as short-period components with the distance from a fault. Thus, taller buildings can experience more severe seismic loads than low-rise buildings while located at the same distance from a fault. Overall, from a seismic design perspective, while members designed for vertical loads are able to provide the resistance required for the vertical aspect of the seismic loads, a dedicated lateral load-resisting system has to be designed to withstand the inertial forces caused by ground motion.

In particular, steel is an ideal material for seismic design since it is very ductile, and it has a great plastic deformation ability that allows the dissipation of seismic energy. In addition, several solutions have been adopted to enhance the seismic performance of steel structures, which is further discussed in Chapter 11.

• Applications

Several applications of outriggers and belt trusses systems are applied to tall buildings worldwide. Some examples are:

- Shanghai Tower, Shanghai, China (Figure 5.16)
- New York Times Tower, New York City, USA (Figure 5.5)
- 300 North LaSalle, Chicago, USA (Figure 5.10)
- Jin Mao Tower, Shanghai, China (Figure 5.13)
- Ref. projects detailed in chap.13 and summarised in Fig. 5.17.

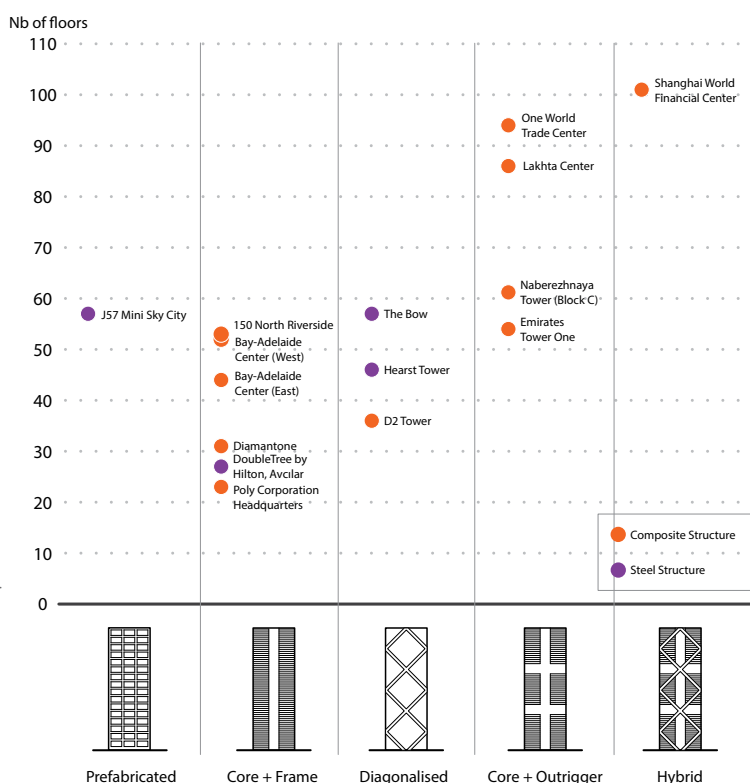
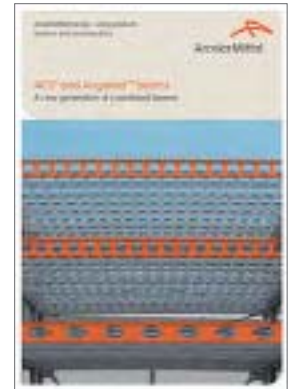

Figure 5.17: Bracing systems of the reference projects



## 6. Beams and floor systems

- Introduction

Floor systems are generally made of a steel beam supporting a metal deck filled with a poured concrete slab. This is called a composite slab (Figure 6.1). Composite slabs act as a diaphragm, allowing the shear forces between the steel beams and the horizontal load forces on the concrete slabs to transfer to the bracing elements. A range of floor systems are suitable for different spans, but there are specific systems that are suitable for high-rise buildings (Table 6.2).

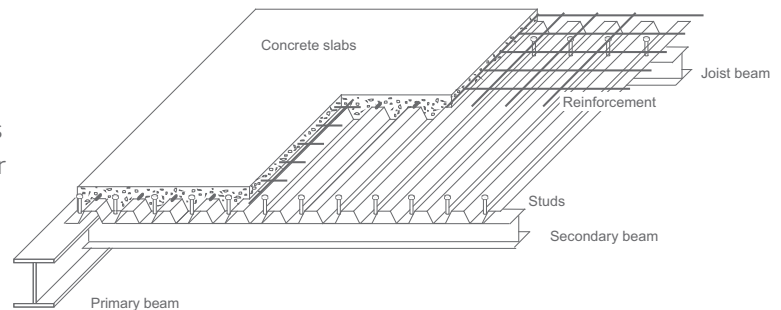
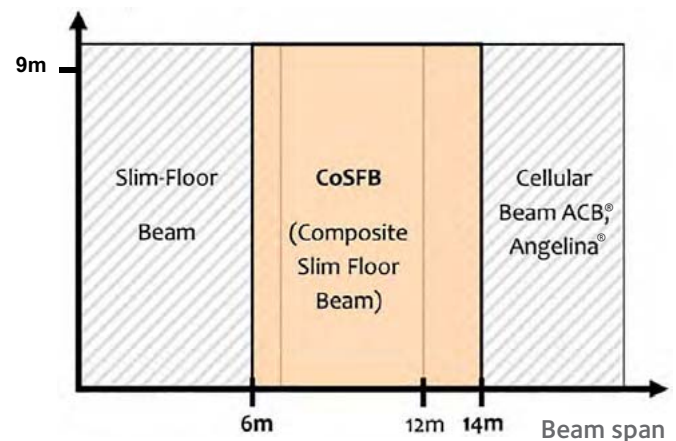

Figure 6.1: Composite floor system

	Span (m)					
	6	8	10	13	16	20
Reinforced concrete flat slab	—					
Integrated beams and deep composite slab	—	—				
Integrated beams with precast slabs	—	—	—			
Composite beams and slab		—	—	—		
Fabricated beams with web openings			—	—	—	
Cellular composite beams			—	—	—	
Composite trusses				—	—	—

Table 6.2: Slab depending on the span

Slab span



- Floor systems specific for high-rise buildings

In high-rise buildings, floor systems must be light and slim to minimise the weight and maximise the usable height of the building. Both requirements can be achieved using castellated beams, which enable an easy integration of building services within the floor system. Another solution which provides minimal floor thickness is the Slim-Floor system, which integrates the slab between the flanges of the steel beam.





**Cellular beam**

- lighter
- smaller
- cheaper for long spans

### • Castellated beams

The use of castellated beams allows a new architectural expression. Structures are lighter, and spans are increased, allowing for more open spaces in buildings. These beams are created by subjecting a hot rolled section to longitudinal cuts along its web, following a specific pattern (Figure 6.3). Once divided, the beam can be reassembled with a longer web, taking advantage of the cutting pattern. These cutting patterns can produce several different castellated beams, including sinusoidal cut (Figure 6.4), cellular (see above) and octagonal. The cutting pattern also allows openings for technical installations to be integrated within the structure instead of below it, which reduces floor-to-ceiling heights. The reduced castellated beams weight, combined with their high strength, can inspire architects to create new structural forms:

- Angelina® (sinusoidal cut)
- cellular
- octagonal.

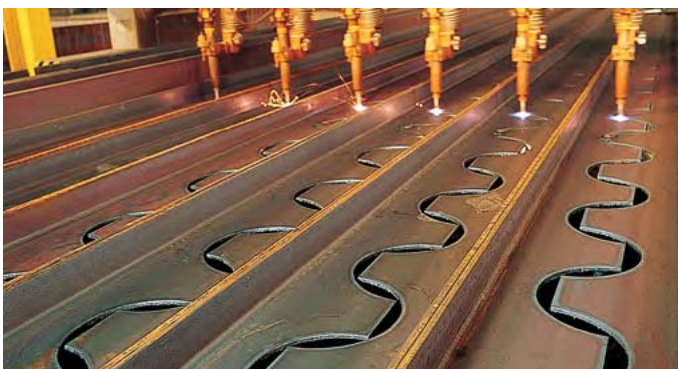

**Figure 6.3: Flame cutting table for hot rolled sections**

The use of castellated beams now provides effective solutions to the demands of project owners. This solution allows large column-free floor areas over a distance from 12 to 18 meters. Additionally, the total floor thickness is 25 to 40cm less than conventional solutions, the beams are about 30% lighter, which allows for more efficient transportation and installation of the beams, and the costs are reduced for spans larger than 10m.



**Figure 6.4: Angelina® beams**

Web openings on castellated sizes are typically 60 to 80% of the beam depth. Stiffeners may be required for elongated openings and large openings should be in areas with low shear forces. Shear or buckling of the web posts can occur between openings, particularly near high point loads or adjacent to elongated openings. In this case, the spacing between openings should be increased or heavier sections should be used.

Angelina® beams and cellular beams are fabricated in modern workshops at ArcelorMittal's rolling mill for heavy sections in Differdange, Luxembourg. The proximity of these manufacturing plants limits transport, maximises responsiveness, and contributes to the competitiveness of the manufacturing costs.

Beam spacing is function of the floor used.

- For composite floor slabs (steel decks), the distance should be:
  - 2,5 to 3m without propping
  - 3 to 5m with propping.
- With pre-stressed concrete floor elements:
  - 2,7 to 7m with propping when required.

ArcelorMittal's flooring Cofradal 200/230/260 and Cofraplus 220 are suitable for 5 to 7m spans.

Typical chord sizes for cellular secondary beams with a 12 to 18m span, a 130mm slab depth, and 3m spacing are presented in Figure 6.5.





Angelina® beam with filled openings at support

Design table:

Cellular beam parameter	Typical spans of cellular beam (m) - S355				
	12m	13,5m	15m	16,5m	18m
Opening diameter (mm)	300	350	400	450	500
Beam depth (mm)	460	525	570	630	675
Top chord	IPE 360	IPE 400	IPE 400	IPE 450	IPE 500
Bottom chord	HE 260 A	HE 300A	HE 340B	HE 360B	HE 400M

Variable action = 3kN/m<sup>2</sup> plus 1kN/m<sup>2</sup> for partitions  
 Slab depth = 130mm; Beam spacing = 3m

Figure 6.5: Sizes of composite cellular beams as secondary beams

### • Slim-Floor systems

The “Slim-Floor” system is a fast, innovative and economical solution, which combines precast slabs, such as prestressed hollow core slabs with specific steel beams (see Figures 6.6 and 6.7).



Figure 6.6: Slim-Floor for parking in IFB (Nantes, France)

The beam is characterised by a lower flange which is wider than the upper flange. This allows the floor slab elements to be put directly onto the lower flange plate of the beam, avoiding downstanding beams and offering working spans of up to 8 meters (Figure 6.8).

ArcelorMittal offers two varieties of Slim-Floor elements, which offer similar advantages.



Figure 6.7: Slim-Floor (Eich Clinic, Luxembourg)

The Integrated Floor Beam (IFB) replaces the lower flange with a wider plate (Figure 6.8), while the Slim-Floor Beam (SFB) attaches a plate wider than the lower flange directly to the bottom of a beam element (Figure 6.9).

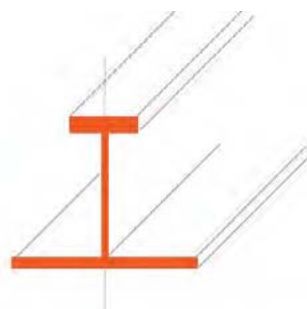

Figure 6.8: IFB system

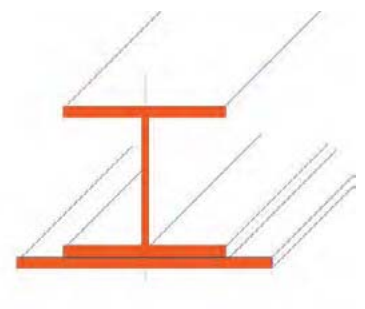
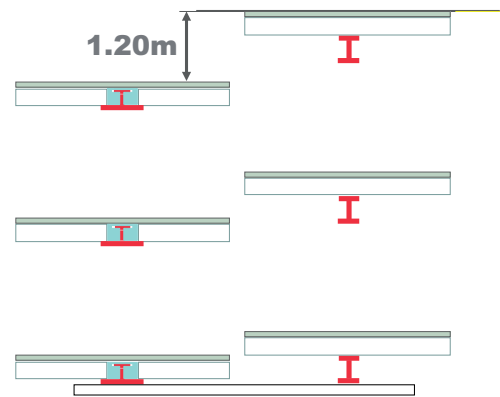

Figure 6.9: SFB system

### Advantages of the Slim-Floor (IFB/SFB):

- floor thickness reduction
- lower floor-to-floor height
- lighter structure
- built-in fire resistance
- easy to build
- competitive pricing
- environmentally-sustainable
- easier integration of under-floor technical equipment
- possible solution for constructing floors of variable thickness.



Height advantage with Slim-Floor

Span of slab (m)	Typical beam size for Slim-Floor beam span - S355			
	5m	6m	7m	8m
5	HE 200 A	HE 240 A	HE 280 A	HE 300 A
6	HE 240 A	HE 280 A	HE 300 A	HE 280 A
7	HE 280 A	HE 300 A	HE 280 B	HE 300 B
8	HE 280 A	HE 280 B	HE 300 B	HE 320 B

Span of slab (m)	Typical beam size for Slim-Floor beam span - S355			
	5m	6m	7m	8m
5	IPE 400	IPE 500	IPE 550	IPE 600
6	IPE 500	IPE 550	IPE 600	HE 500 A
7	IPE 550	IPE 600	HE 500 A	HE 600 A
8	IPE 600	HE 500 A	HE 600 A	HE 600 B

Figure 6.10: Design tables: - S355 - for office buildings; A welded plate - 20mm thick and 150mm wider than the section is used in all cases.

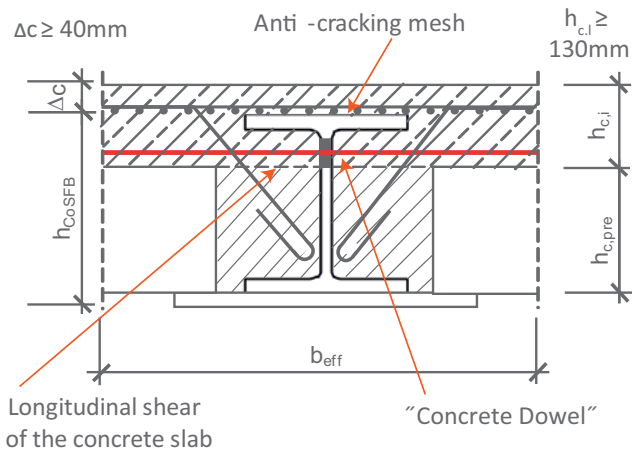

CoSFB - 250mm < Slab thickness ≤ 300mm  
Steel S355

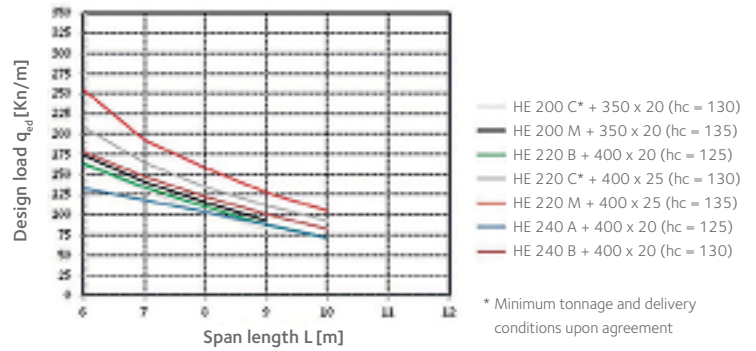

CoSFB made up with "concrete dowel" and Slim-Floor beam

### • SFB

Application range of SFB:

Typical non-composite Slim-Floor Beams have a limited inertia and stiffness because of their slim construction height.

- the design is mainly driven by the SLS (deflection + vibration)
- typical beam spans are up to ≈ 7m.

### • CoSFB

The CoSFB is a Slim-Floor beam system where the floor acts **compositely** with the steel beam. Due to the wider lower flange of Slim Beam systems, it allows a seamless integration with hollow core slabs, concrete plants, or prefabricated slab elements produced by ArcelorMittal, such as Cofraplus and Cofradal systems (Figure 6.11 to



Figure 6.11: CoSFB and Cofraplus 220

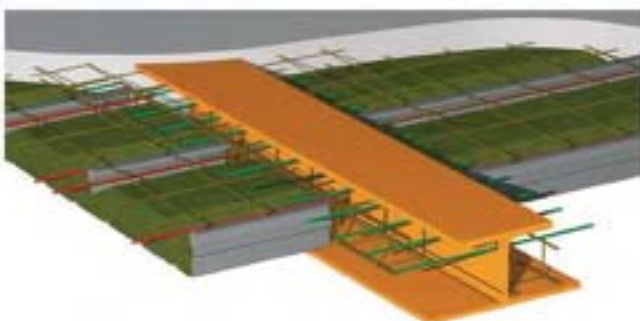

Figure 6.12: CoSFB and Cofradal 260

Figure 6.13). Composite action is ensured by the so-called "concrete dowel" (see Figure above) composed of holes in the web with adequate reinforcement. This system is referred as Composite Slim-Floor Beam or CoSFB systems.

A typical non-composite Slim-Floor beam can only span up to 8m, as their reduced construction height limits the inertia and stiffness of the system. Once a Slim-Floor beam is integrated into a composite system, beams can span from 6 to 14m (even up to 16m in some cases). It also allows for an overall construction height of only 40cm combined with an integrated fire resistance for up to 90 minutes.

**Application range of CoSFB:**

- beam span from 6m up to ≈ 14m (16m possible in some cases)
- beam spacing from 5m to 10m



Figure 6.13: CoSFB

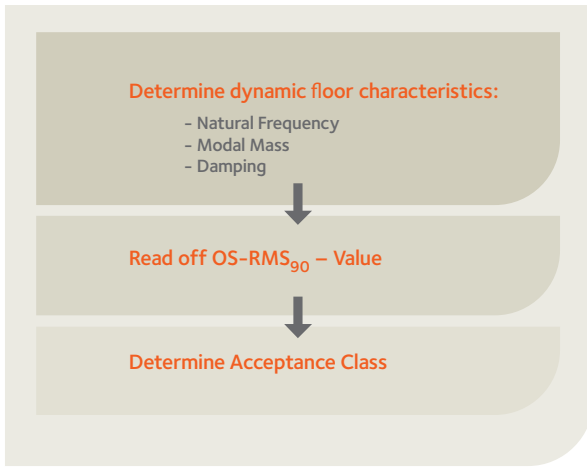

**Design procedure for vibrations**

• **Vibration**

Floor structures are designed for ultimate limit state and serviceability limit state criteria:

- ultimate limit states are those related to strength and stability;
- serviceability limit states are mainly related to vibrations and hence are governed by stiffness, masses, damping and the excitation mechanisms.

When developing these floor systems for tall buildings, the ultimate limit states, such as strength and stability, are not the only thing that needs to be considered. Serviceability limit states, which are related to floor vibrations, a common trait of tall buildings, must take stiffness, massing, damping and excitation mechanisms into account. The serviceability criteria and required comfort of occupants are likely to govern the design.

The perception of vibrations and the individual’s feeling of annoyance depends on several aspects, such as:

- the direction of the vibration,
- the posture of people such as standing, lying or sitting,
- the daily activity of the occupants (persons working in the production of a factory perceive vibrations differently from those working in an office or a surgery),
- age and health of occupants.

Thus, the perception of vibrations is a very individual problem that can only be described in a way that fulfills the acceptance of comfort (A→F) of the majority. The design procedure is summarised by the following diagrams:



Class	OS-RMS <sub>90</sub>		Function of Floor									
	Lower Limit	Upper Limit	Critical Workspace	Health	Education	Residential	Office	Meeting	Retail	Hotel	Industrial	Sport
A	0.0	0.1	Recommended	Recommended	Recommended	Recommended	Recommended	Recommended	Recommended	Recommended	Recommended	Recommended
B	0.1	0.2	Critical	Recommended	Recommended	Recommended	Recommended	Recommended	Recommended	Recommended	Recommended	Recommended
C	0.2	0.8	Not recommended	Critical	Recommended	Recommended	Recommended	Recommended	Recommended	Recommended	Recommended	Recommended
D	0.8	3.2	Not recommended	Not recommended	Critical	Recommended	Recommended	Recommended	Recommended	Recommended	Recommended	Recommended
E	3.2	12.8	Not recommended	Not recommended	Not recommended	Critical	Recommended	Recommended	Recommended	Recommended	Recommended	Recommended
F	12.8	51.2	Not recommended	Not recommended	Not recommended	Not recommended	Critical	Recommended	Recommended	Recommended	Recommended	Recommended

The OS-RMS values correspond to the harmonic vibration caused by one relevant step onto the floor. As the dynamic effect of people walking on a floor depends on several boundary conditions, such as weight and walking speed, their shoes, flooring, etc., the 90% OS-RMS (One Step-Root Mean Square<sub>90</sub>) value is recommended as assessment value. It represents an effective step velocity of 90% of people walking normally. Detailed description of the methodology is given in the Arcelormittal brochure “Design guide for Floor Vibrations” available on [sections.arcelormittal.com](https://sections.arcelormittal.com). A summary is provided at the top left of the page.



• Predesign tools

Software and design tables, as well as design guidance are available on [sections.arcelormittal.com](http://sections.arcelormittal.com) for all of the floor systems, including castellated beams, Angelina® beams, Slim-Floor and CoSFB systems.

Pre-design chart: Composite Angelina® based on HEB, S355 with COFRAPLUS 60

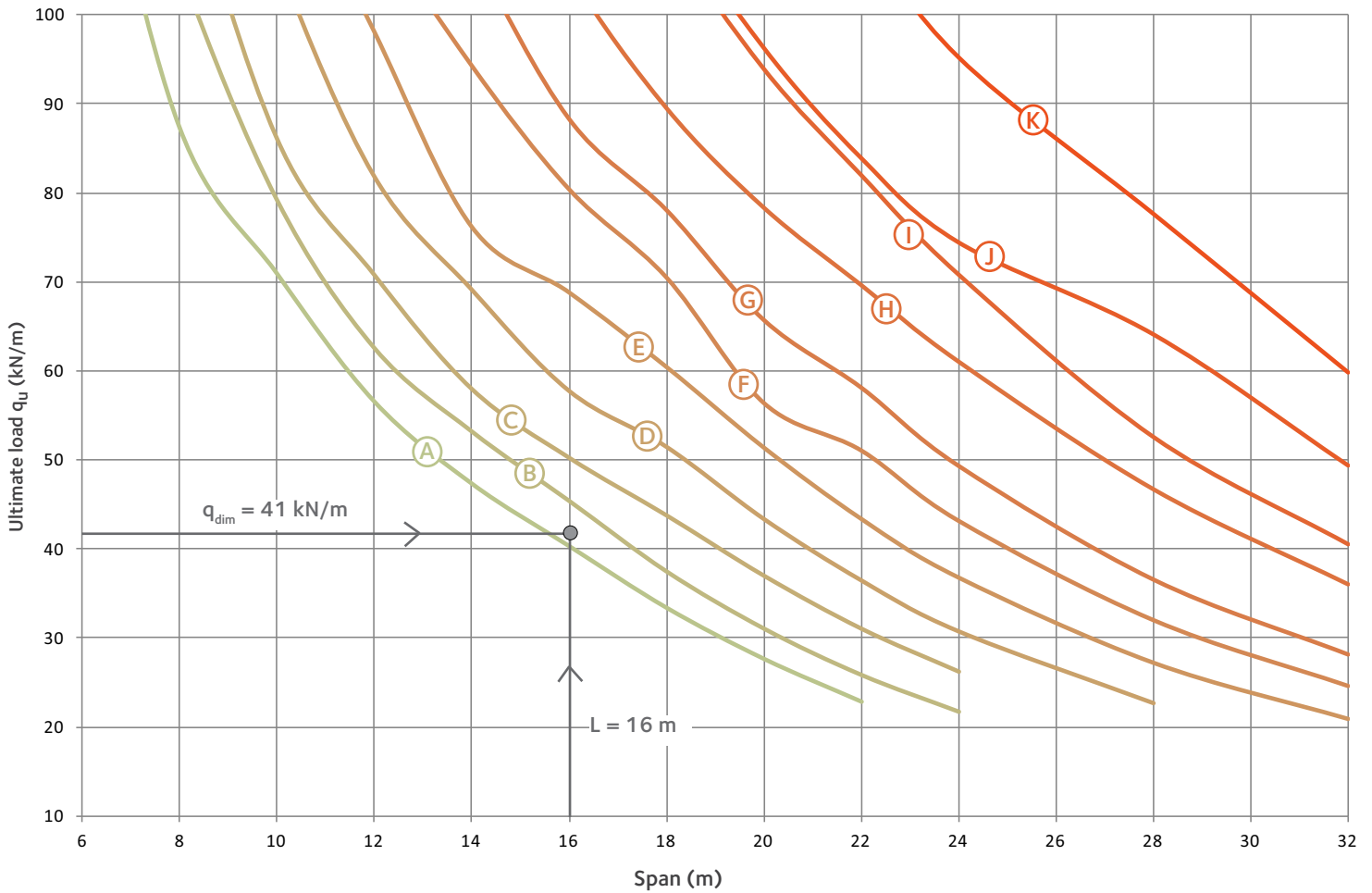

Sections	Dimensions (mm)					Ultimate load $q_u$ (kN/m) according to the span (m)											
	$a_0$	w	s	e	$H_t$	6	8	10	12	14	16	18	20	22	24	28	32
(A) HE 300 B	315	250	315	1130	457,5	129,3	87,5	71,0	56,6	47,4	40,4	33,5	27,7	22,9			
(B) HE 320 B	335	250	335	1170	487,5	138,5	105,6	79,3	62,6	53,3	45,4	37,5	31,1	25,9	21,7		
(C) HE 360 B	380	300	380	1360	550		120,6	86,2	70,8	58,0	50,3	43,8	37,0	31,0	26,2		
(D) HE 400 B	420	300	420	1440	610		137,9	106,4	81,9	69,1	57,7	51,4	43,3	36,4	30,7		
(E) HE 450 B	475	300	475	1550	687,5		151,5	120,9	98,1	76,2	68,8	60,4	51,3	43,3	36,7		
(F) HE 500 B	525	300	525	1650	762,5			132,4	111,1	94,3	80,4	70,5	56,4	51,1	43,2		
(G) HE 550 B	580	300	580	1760	840				130,6	107,7	88,4	78,1	65,7	58,1	49,4	12,6	
(H) HE 650 B	680	300	680	1960	990				153,2	125,4	104,8	89,5	78,3	69,6	61,0	16,2	11,0
(I) HE 700 B	730	300	730	2060	1065					154,9	130,7	109,8	94,0	82,0	70,9	20,2	13,7
(J) HE 800 B	780	300	780	2160	1190						136,3	112,6	96,3	83,9	74,4	25,2	17,1
(K) HE 900 B	830	350	830	2360	1315							155,9	128,6	109,9	95,2	31,9	21,8



**Slim-Floor IFB - Slab thickness < 200 mm**

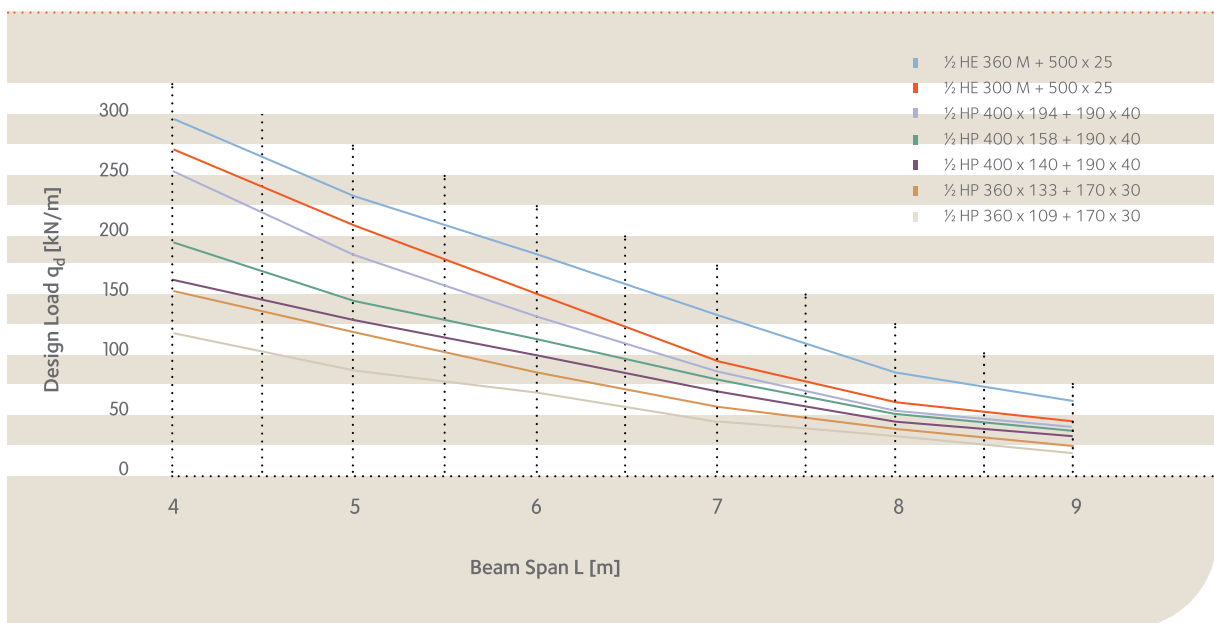

**CoSFB - 300mm ≤ Slab thickness ≤ 350mm - Steel S460**

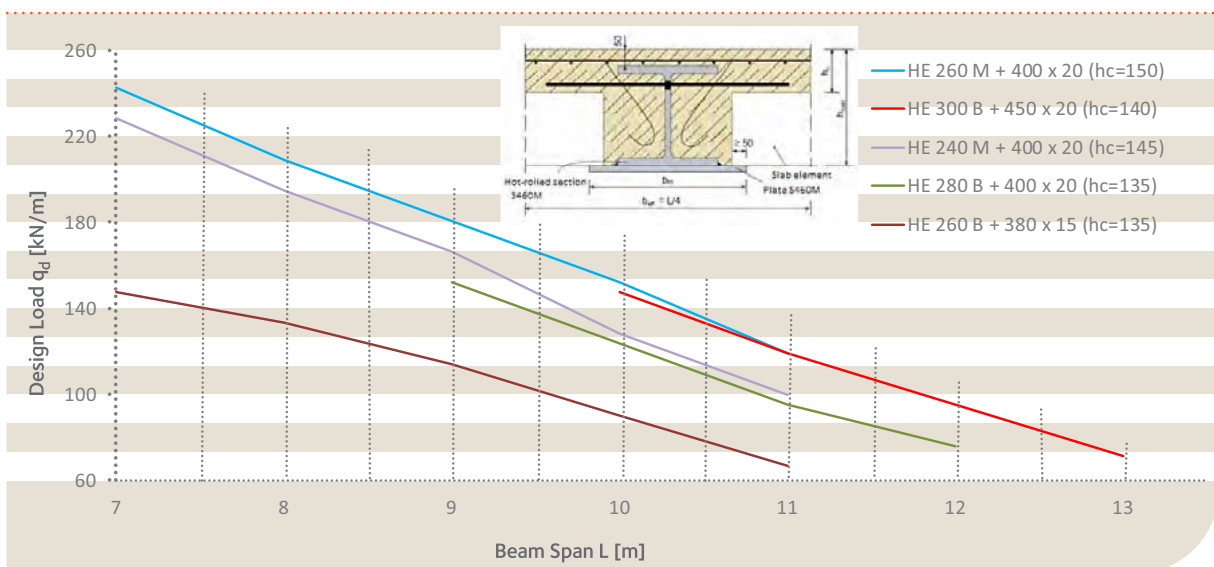

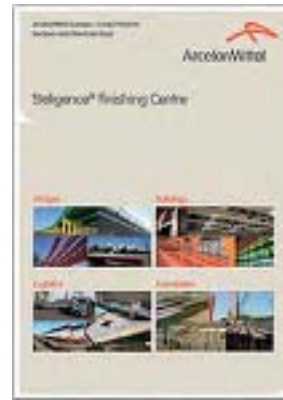

## 7. Connections

Steel connections are the structural elements used to hold a steel structure together. The selection of connection depends on many aspects, including the type of loading required, the strength and stiffness required, economy and the level of difficulty for construction. The connection choice can have a direct influence on the cost of a steel structure. For the structural members in previous sections, they are generally more efficient if they adequately serve the structural requirements with less weight and less material, which is not always the case for steel connections. Some connections, although efficient in material use, may still be expensive to erect. Furthermore, additional cost saving can be made if the structural design uses many similar connections, instead of many custom-made connections. Thus, it is imperative that connections are considered early in the structural design process to be economically and structurally efficient, and ArcelorMittal sections offers several options for efficient steel connections.

### • Columns

In high-rise buildings, gravity columns must be perfectly spliced to each other to ensure that the axial load is correctly transmitted between the end of the columns section and not through the splice plate. Columns sections from ArcelorMittal of the same series have the same distance between the flanges, or an equal chamber size, so that they can easily be stacked on each other. ArcelorMittal also offers the possibility to mill the end of sections to ensure that they will perfectly sit down on each other. Two types of connections are available for gravity columns:

#### - Bolted Connections:

Column splices (Figure 7.1) are designed assuming they must resist both the axial compression and, where appropriate, a nominal moment from the connection to the beams. The plates provide the splice with adequate stiffness and tying resistance to ensure that the two ends of the columns are always in compression.



Figure 7.1: Bolted connection of two HD/UC/W columns

#### - Welded Connections:

Jumbo and Super Jumbo columns can be connected by welding (Figure 7.2). The joint detail and joint preparation are two of the most important factors which will affect the quality and cost of the completed weld. Welding offers several advantages:

- smaller connection footprint
- no additional connection elements such as bolts, nuts, washes, etc.
- no reduced cross section resistance due to holes
- continuity of the structural element at the joint ensuring higher stiffness and clear load path transmission
- high reliability through adequate quality control procedure (procedure for beveling, welding, control during and after welding)



Figure 7.2: Column joint before welding

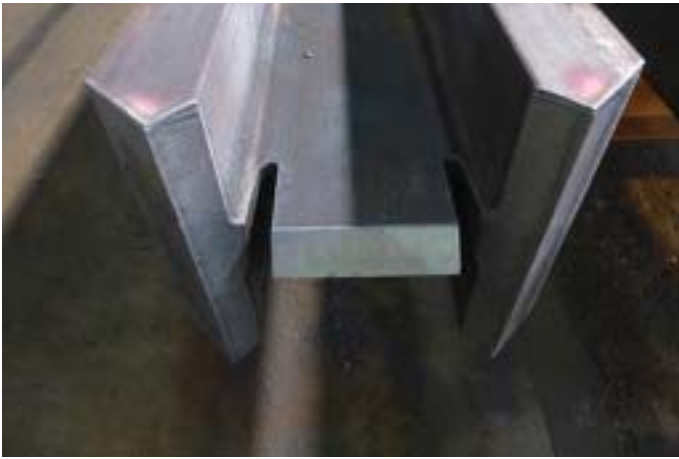

**Figure 7.3: CJP butt weld preparation for Jumbo column**



**Figure 7.5: Gusset plates connection in S355 (Gr .50) with S460 (Gr. 65) beams at Mariner Stadium (Seattle)**

Partial Joint Penetration (PJP) welded connections are recommended for gravity columns unless conditions occur which would require Complete Joint Penetration (CJP). PJP welds are groove welds that do not extend completely through the thickness of a column section and are more typical, while CJP (Figure 7.3) welds extend completely through the section and are used when the column is subjected to tension, seismic activity, etc.

- *Fit of column compression joints and base plates:*

Lack of contact bearing shall not exceed a gap of 2mm, regardless of the type of splice used. If the gap exceeds 2mm and is less than 6mm, it shall be filled with non-tapered steel shims. Shims need not be other than mild steel, regardless of the grade of the column material.

• **Truss connections**

When designing bracing systems for tall buildings, connection geometries should be designed to achieve intersections at the nodal points of sections, which avoid bending moments being introduced into the chord. A truss girder system using I-sections is an efficient and commercially viable alternative to existing solutions, due to the great range of cross sections available. It is a flexible system which allows for large clear span structures without internal columns. Like columns, these connections can be achieved using two different strategies:

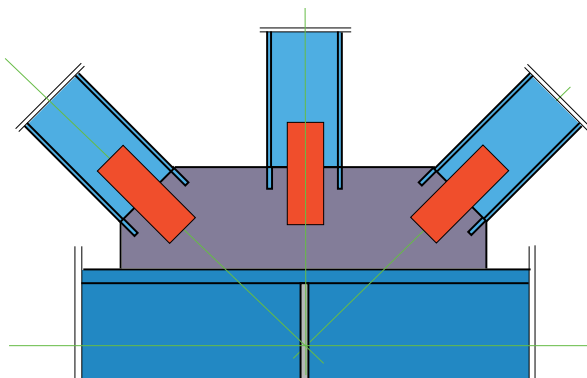

**Figure 7.4: Gusset plates connection**

- **Bolted Connections:**

Unlike columns, bracing systems use a web-based connection, and using gusset plates and stiffeners, forces from trusses can be adequately transmitted to beams and columns. This can be seen in Figure 7.4 to 7.7, with the I-sections oriented in such a way, using gusset plates, that bending moments are avoided. Widely used in belt and outrigger trusses, this type of connection is well adapted for big trusses supporting the high loads of skyscrapers.

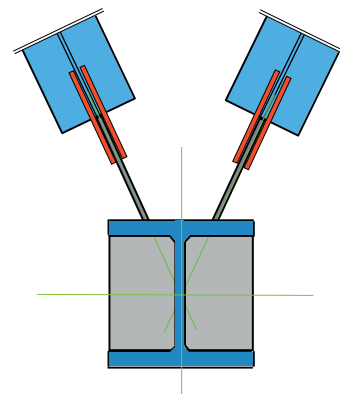

**Figure 7.6: Gusset plates connection (cross-sectional view)**

- **Welded Connections:**

By changing the orientation of the I-sections, additional constructional elements (like plates) are no longer required. The function of the gusset plates and stiffeners is taken over by the flanges of the chord and the brace members with the result of a simple and clear-cut form. It is obvious that this solution is more economical than using gusset plates. This statement is supported also by a quantitative comparison: since stiffeners and gusset plates are no longer required, the amount of welding is reduced by 77% and an overall 19% cost reduction. With this method, different shapes can be welded together if they have the same chamber\* size (See Figure 7.8 to 7.11). HD series sections, especially HD 360 and HD 400, are also suitable. For instance, the 22 sections from the HD 400 series have the same chamber size of 290mm. A truss girder system using I-sections is an interesting and commercially viable alternative to existing solutions,





Figure 7.7: Mariner Stadium close up on gusset plates connection in S355 (Gr. 50) with S460 (Gr. 65) beams



Figure 7.9: Equal chamber\* size

due to the great range of cross sections available. It is a flexible system which allows for large clear span structures without internal columns.

European shape	Area		Chamber* size (mm)	Depth (mm)	Width (mm)
	cm <sup>2</sup>	%			
IPE 300	53,8	17	278,6	300	150
IPE O 300	62,8	20	278,6	304	152
HE 320 A	94,6	30	279,0	301	300
HP 305 x 88	112,1	35	277,1	301,7	307,8
HP 320 x 88,5	112,7	36	279,0	303	304
HP 305 x 95	121	39	277,1	303,7	308,7
HP 320 A	124,4	40	279,0	310	300
HP 320 x 103	131,0	42	279,0	307	306
HP 305 x 110	140,1	44	277,1	307,9	310,7
HP 320 x 117	149,5	47	279,0	311	308
HE 320 B	161,3	51	279,0	320	300
HP 305 x 126	160,6	51	277,1	312,3	312,9
HP 320 x 147	186,9	59	279,0	319	312
HP 305 x 149	189,9	60	277,1	318,5	316
HD 320 x 158	201,2	64	279,0	330	303
HP 305 x 180	229,3	73	277,1	326,7	319,7
HP 320x184	234,5	75	279,0	329	317
HP 305 x 186	236,9	76	277,1	328,3	320,9
HD 320 x 198	252,3	80	279,0	343	306
HP 305 x 223	284	91	277,1	337,9	325,7
HE 320 M	312,0	100	279,0	359	309

Figure 7.8: Selection of shape according to the rolling programme

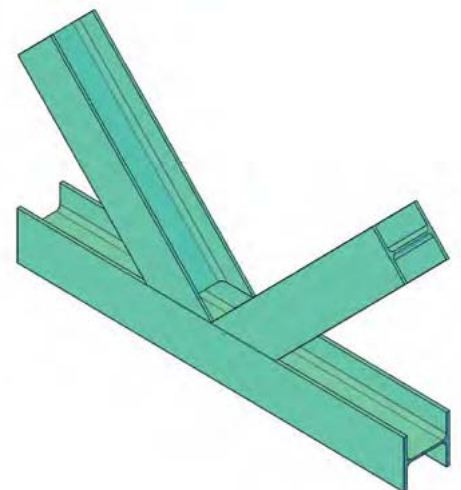

Figure 7.10: Various shapes with equal chamber\* size

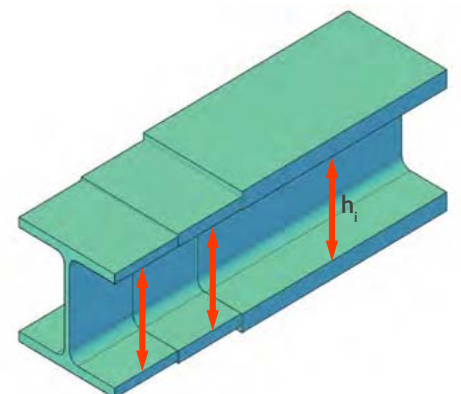

Figure 7.11: Equal chamber\* size

\*inner distance between flanges



Figure 7.12: Bevel preparation on Jumbo



Figure 7.14: Mistral Residential Tower, Izmir, Turkey

- Steligence® Fabrication Centre

The Steligence® Fabrication Centre manufactures custom joints for steel sections. It offers a complete range of fabrication and finishing operations to improve the technical capabilities for steel sections, including cold sawing, drilling, cambering, bending, oxyacetylene cutting, flame cutting, milling and plasma cutting.

One of the main fabrication capabilities of the finishing centre is bevel preparation, which allows joints of steel sections to be ready for welding, including PJP and CJP welds (Figure 6.12). The joint design and the joint preparation are two of the most important factors which affect the quality and cost of the completed weld. Time spent in preparing the joint properly is more than compensated by higher welding speeds and better-quality welds. Correct and accurate edge preparation is essential to produce quality welds. Edge preparations are required to achieve full penetration to the root of the joint helping the welder to produce quality joints.

All weld access holes required to facilitate welding operations shall have a length (1) from the toe of the weld preparation no less than 1,5 times the thickness of the material in which the hole is made.

The height (h) of the access hole (Figure 7.13) shall be adequate for deposition of sound weld metal in the adjacent plates and provide clearance for weld tabs for the weld in the material in which the hole is made, but not less than the thickness of the material.

In structural shapes all beam copes and weld access holes shall be shaped free of notches or sharp reentrant corners.

The main structure of the Mistral Tower in Izmir (Figure 7.14), a 200m high building is composed of the HD beams, ranging from 400 x 262 to 400 x 1086. In total, 1,485 tonnes of steel with chamfers, which were flame cut in the ArcelorMittal Steligence® Fabrication Centre, were delivered on time.

- Delivery conditions:

- weld preparation of steel sections with flange thickness up to 140mm
- surface quality according EN 1090-2 / ISO 9013 or AISC 303
- the thermally cut surfaces of beam copes and weld access holes are ground to bright metal and inspected by either magnetic particle or dye penetrant methods, if specified.

- Pre-qualified connections

Structural members with long uninterrupted spanning and large loading capacity are needed in the design of tall buildings, convention centres, sport arenas and airport concourses. The latest product developments made by ArcelorMittal permits the use of large jumbo steel profiles. When such profiles are used in areas of high seismicity, the welded connection design requires a careful development from welding performance specifications (WPS) point to ensure that the required rotational capacities to reach interstory drifts can be developed. One technique used to control the flexural demand from the beam is to utilise

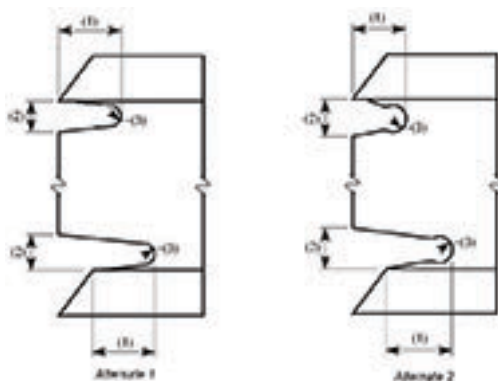
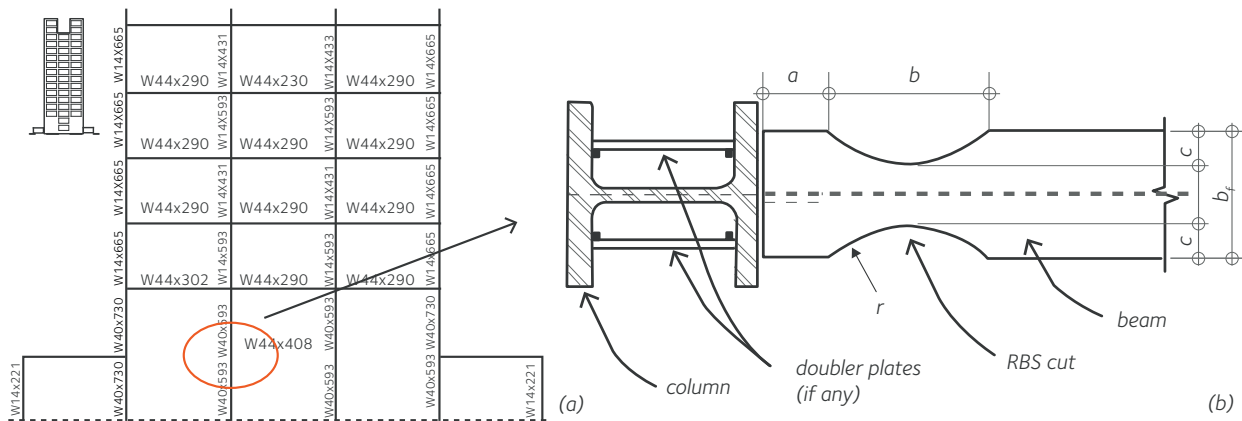

Figure 7.13: Weld access hole geometry

- (1) Length: Greater of  $1.5 \times t_w$  or 11/2 in. (38 mm). Tolerance is  $\pm 1/4$  in. (6 mm).
- (2) Height: Greater of  $1.5 \times t_w$  or 1 in. (25 mm) but need not exceed 2 in. (50 mm).
- (3) R: 3/8 in. min. (8 mm). Grind the thermally cut surfaces of access holes in heavy shapes.



**Figure 7.15: a) Sections at the lower storeys of the Case study building, b) Plan detail of the examined beam-column connections with doubler plates.**

reduced beam sections (RBS), which effectively limit the demands at the beam-column interface (Figure 7.15,b). The RBS concept was proposed initially in the late 1990s to alleviate problems encountered in the 1994 Northridge Earthquake with conventional welded connections. Following, different shapes of RBS have been studied along the time. The current AISC Provisions for Steel Buildings (AISC 360-16), Seismic Provisions (AISC 341-16) and the Provisions for Prequalified Connections for Special and Intermediate Steel Moment Frames (AISC 358-16) allow the use of these connections but only for sections up to 900 mm in depth and 450 kg/m in weight. To extend the coverage of these specifications to much larger sections, a joint experimental and analytical program was undertaken by Virginia Tech and ArcelorMittal. Another main objective of the experimental programme was to determine an acceptable balance between the deformation obtained from flexural yielding of the RBS and shear yielding of the column web PZ. The experimental campaign is based on a trial design to determine the realistic member size in buildings with high seismicity area. The study consisted of a square office building tower with fifteen stories and a large open atrium at the 1<sup>st</sup> floor. Special Moment Frames with RBS connections were

considered exclusively for the seismic-load-resisting system. These frames are located at the perimeter and are typically three bays wide, except at the lower levels as shown in Figure 7.15a. From these typical frames, sample connections were extracted as possible test specimens. Figure 7.15b depicts the schematic of a specimen. Each specimen exceeds the size limitation outlined in the AISC 358-16 in at least one regard.

The specimens were secured within a rigid frame that is affixed to the strong floor laboratory as illustrated in Figure 7.16 and the schematic representation in Figure 7.17. The pieces in red indicates where the frame was being fixed to the strong floor. The specimens were tested in the horizontal orientation in displacement control with the actuators reacting to the testing frame. The specimens were subjected to the loading protocol described in AISC 341-16.



**Figure 7.16: Specimen in testing orientation with two actuators.**

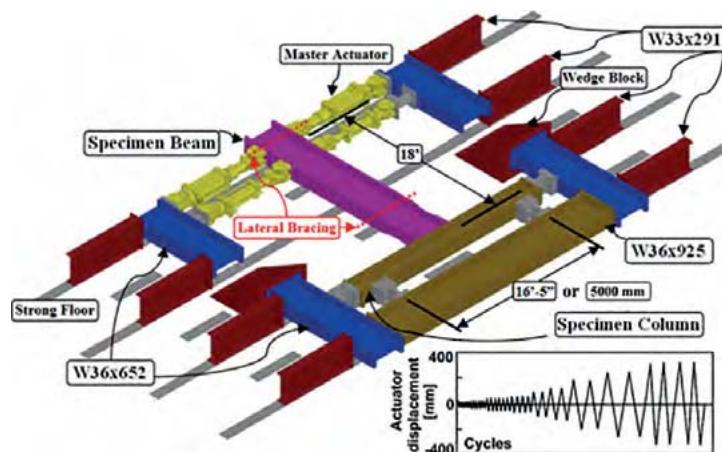

**Figure 7.17: Test setup with four actuators and loading protocol (ANSI/AISC 341-16).**

The test results, especially the  $M-\theta$  response indicates typical flexural yielding and post-buckling softening after the maximum capacity was reached. Figure 7.18 shows the yielding patterns of SP2 at the end of the test.



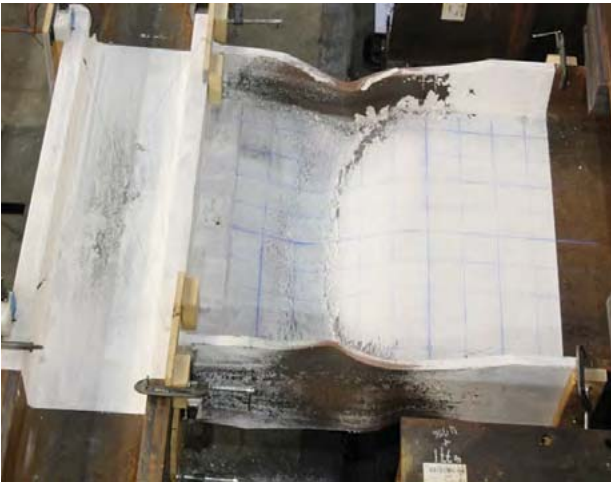

Figure 7.18 Images of the SP2 test specimen in the plastic regime

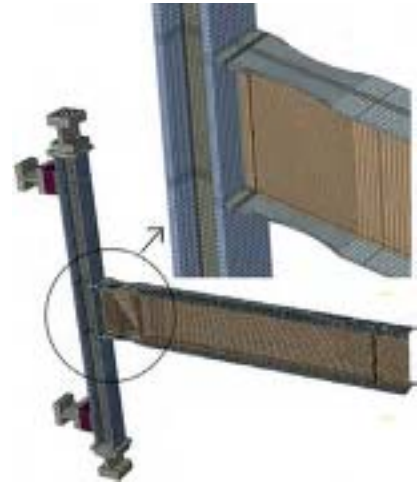

Figure 7.19. Abaqus Numerical model of SP2.

To obtain a more detailed insight into the behaviour, three-dimensional (3D) models of beam-column assemblages with RBS connection were constructed and analysed using the non-linear finite element (FE) program ABAQUS (DSS, 2014). Eight-node brick elements (C3D8R) were used in all models. Extruded solid elements from heavy W sections representing the column were connected to the beams using tie constraints. Special attention was given to the characteristics of the RBS region and the column PZ by considering the exact measured dimensions from the experimental specimens. The specimens, including the four stub elements made of W sections used as boundary conditions, were modelled together (Figure 7.19).

The non-linear numerical simulations of the all four tests are illustrated, in terms of  $M-\theta$  curves, in Figure 7.20. Comparison with the test results indicate that the analysis provides an accurate representation in terms of stiffness and yield strength as well as overall hysteretic response.

Importantly, the models can capture closely the initiation of local flange buckling as well as development and distribution of plasticity in the RBS and PZ regions. The experimental and numerical results showed that the strength, stiffness, ductility, hysteretic response and failure mode of such connections are largely dependent on the beam and column section sizes. The results indicated that RBS beam sections with relatively high depth-to-web thickness slenderness ratios develop reliable failure modes characterised by extensive yielding at the RBS, followed by yielding at the panel zone (PZ) and ultimately, flange buckling at RBS. Also, for relatively deep columns, force induction from beam flanges, combined with RBS flange buckling, could produce out-of-plane column rotation. These connections developed responses characterised by stable hysteretic response, a relatively strong PZ and reliable ductility levels. In contrast, compact sections with relatively low depth-to-web thickness ratios may develop unreliable response with yielding developing almost concomitantly and at RBS and PZ, having a relatively equal contribution to the total connection deformation. Numerical simulations showed that for connections with relatively compact sections, a higher concentration of stresses may occur at the PZ and at the beam, web with lower stress levels developing at the RBS flanges. These observations indicate the need for an alternative design procedure of RBS for connections incorporating large compact sections. More importantly, the connections investigated in this paper reached reliable rotational capacities, that correspond to a minimum inter-story drift required by North American prequalification standards.

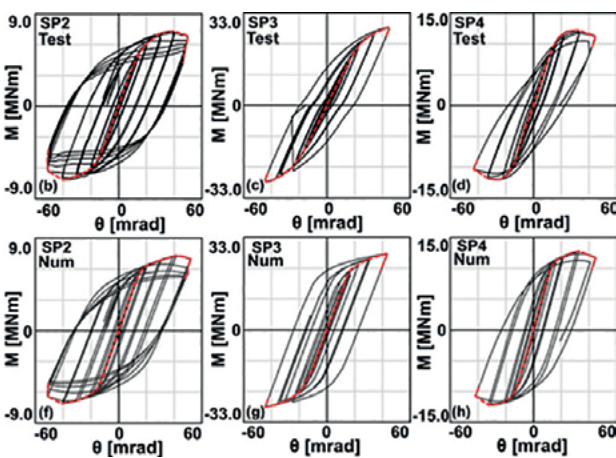

Figure 7.20 Comparative assessment of  $M-\theta$  curves between the experimental tests and numerical simulations.

Corresponding code changes based on the results of this research are expected in the next publication of AISC 358.



## 8. Foundations for high loads

For decades, steel bearing piles, plunge columns, and king-post piles have been used as a cost-efficient solution for deep foundations, especially when high vertical loads need to be transferred into the foundation soil, which is a common trait of tall buildings. All wide-flange beams are suitable for this and HP steel piles are optimised for this type of application. Compared to normal beams, the radii of gyration of these special, wide-flange beams, which have identical flange and web thicknesses, are distributed more evenly around the two main axes.

- Steel foundation properties

Thanks to the large range of standard sections and HP piles, the design engineer can find the ideal solution in terms of bearing capacity and pile driving properties for their tall building project. In addition, high-strength steel grades, such as HISTAR®, can be used to reduce the required amount of steel and maintain the bearing capacity, which will optimise costs. The specific shape of the pile and the properties of

the steel means that HP piles can be used in various soil conditions, and as it is a finished product, the quality can be tested in advance.

Additionally, the piles can be subject to loads immediately after their installation and do not require any time to settle. Once installed, there are various methods for predicting the bearing capacity of the piles. For high-rise projects, static tests or PDA tests (Pile Driving Analyser tests) can be carried out on site to immediately determine the possible bearing capacity and define the safety factor more accurately than when empirical calculation methods are used.

Steel piles generally obtain their bearing capacity through skin friction. In suitable soils, the point bearing pressure can also be considered in addition to the skin friction capacity. There are various ways to further increase the skin friction and point-bearing pressure, including, but not limited to, cased piles with specially designed tips. Also, reinforcement can be added to the base of driven piles to increase the cone friction resistance and provide additional support for high-rise buildings (Figure 8.1).

Rolled sections can be supplied within lengths up to 40 meters, as seen in the Wilhelmshaven Power Plant, which uses HE 800 B sections between 33,8 and 38,8m (Figure 8.2). If required, sections over 40 meters can be achieved by means of special fasteners or by welding. As the soil conditions can only be estimated during the initial phases of the project, using steel sections is a great advantage, as it allows to flexibly respond to soil layers and conditions during construction.

- Installation of steel piles

Piles are normally installed using pile hammers, which are so strong and flexible that they can drive piles into extremely compact soils without negatively affecting the surrounding area. Any vibrations and noise can be controlled through various control systems.



**Figure 8.1: Driven piles with reinforcement at the base to increase the cone friction resistance and thus provide support for high loads**

## King Post Piles with Jumbos



Instead of using two UC356x406x509 in S355M for plunge columns (= king post piles) applications



only one UC356x406x1299 in HISTAR® 460 is used, which allows a weight reduction of 20% and easier assembly.

There are also other sheet pile driving systems, such as vibratory pile driver or sheet pile presses, which allows for further flexibility in the installation process.

Piles can be used in almost all types of soil. Even if soft layers of soil lie above the compacted, load-bearing soil, piles are still reliable and economic since the soft layers have neither a negative effect on the installation nor on the bearing capacity of the piles. For high-rise projects that require minimal soil movements, a top-down construction method can be used, which can also reduce construction time (Figure 8.3). Furthermore, examinations of steel piles that have been removed from the soil after 50 to 80 years have shown that the total reduction in steel thickness due to corrosion is so minimal that no impairment of their bearing capacity is to be expected.

- Advantages of using steel piles

Finally, it should be mentioned that because of the inherent properties of steel, the piles can be subjected to both compressive and tensile loads. This ability makes them particularly useful for construction that, depending on the load cases (earthquake, water level, etc.), requires the piles to resist to both compressive and tensile forces. Tension piles often present a more optimised and cost-efficient solution, when compared to injection or bored piles. Ultimately, even if high tensions occur (e.g., during pile driving), especially in compact soils, no threat to the stability of the piles occurs.



**Figure 8.2: Use of HE 800 B with lengths ranging from 33,80 to 38,80m for foundations (Wilhelmshaven power plant).**



**Figure 8.3: 26-metre long foundations for the top down construction method with no splicing required.**

Bending stress caused by the lateral pressure of soft layers of soil or horizontal loads above the foundation plate can be transferred by the bending capacity of the steel sections. The same is true for horizontal movements caused by earthquakes.

In conclusion, steel piles can be used for a large number of foundation applications in high-rise buildings, as they are ideally suited for high vertical loads in most soil conditions.

## 9. Fire resistance

High-rise buildings present several unique safety challenges that are not found in traditional low-rise buildings; longer egress times and distance, evacuation strategies, fire department accessibility, smoke movement and fire control. Due to advanced structural technologies, buildings are constantly being built taller, which means a greater number of occupants need to travel greater distance to evacuate a building during an emergency. During a fire event, the structural members of a building need to be able to withstand heat and open flames long enough to allow all occupants to exit. Steel structural elements, particularly gravity columns, can withstand excessive heating for 90 to 120 minutes, so it is an optimal solution when taking fire safety concerns into account. Several ways to provide steel fire safe solutions exist:

- thermal insulation products (reactive coatings, spray, boards) which delay the time needed for steel to reach the critical temperature
- composite steel-concrete solutions
- fire engineering solutions.

### Thermal insulation products

#### • Intumescent coatings

Intumescent “painting” is a fire protection strategy that is typically used for exposed structural steel elements and can resist high temperatures for 30 to 120 minutes.

before fire



after fire



Figure 9.1: Intumescent coating layer

It is a reactive paint coating that expands under high temperature to provide adequate insulation to the steel member (Figure 9.1). As a paint coating, it offers several benefits:

- no augmentation of exterior dimensions
- easy and quick application
- application possible on complex structural details
- some coatings have a fire resistance up to 120 minutes and are resistant to corrosion.

The required Dry Film Thickness (DFT) of the paint depends on the critical temperature and on the section factor ( $A_p/V$  value). Small steel beams require a high DFT, and the relative cost of the coating to the cost of the steel sections can be comparable. In Jumbo size steel sections, the DFT can be quite small due to the very low section factor, therefore the reactive coating cost could be less than 10% of the cost of the steel.

#### • Spray

Spray protection is generally used on non-visible structural elements, located above suspended ceiling, or on complex structural elements like trusses etc. Although not as visually



Figure 9.2: Protection by spraying on ACB® beam

appealing as intumescent paint, it offers the same benefits at significantly lower costs, which makes it an ideal (and economic) solution for non-visible structural elements (Figure 9.2). There are two kinds of spray products available, depending on the required fire resistance: low density products, which is made with mineral fibres, and high-density products, which are composed of cement, plaster, etc.



### • Boards

Board fire protection is generally applied for visible beams and columns. Board protection advantages are:

- the structural elements can remain visible
- boards have a well-defined guaranteed thickness
- no steel preparation needed
- a plaster layer can be applied to improve aesthetics aspects.

Board fire protection generally does not suit complex structures (truss), castellated beams or external elements subjected to humidity.

They are either low-density products made from mineral fibres or high-density products made of plaster, vermiculite and calcium silicate. Boards are fixed with staples, glue, nails or screws. The thickness of the boards depends on the required fire protection and the section factor of the element.

### Composite steel/concrete solutions (Figure 9.3, 9.4)

Composite structural solutions that use both steel and concrete are ideal solutions that inherently provide fire protection. Systems, such as optimised composite sections, partially encased (for the top levels; not adequate for heavy sections), fully encased, megacolumns, CoSFB (Chapter 3 and 5) are all exemplar examples of composite structural systems. The fire resistance is built into the system itself, which can save valuable floor area, if composite columns are used, and increase the floor-to-ceiling heights, if composite floor systems are used.

Even a combination of protection solutions can be used, i.e. partially encased columns and sprayed beams.



Figure 9.3: Partially encased



Figure 9.4: Fully encased

### Fire safety engineering studies

Adequate fire protection can be achieved for a reduced cost by applying several advanced fire engineering methods, which can optimise or, in some cases, completely avoid passive fire protection. One of the options available is the FRACOF (Fire Resistance Assessment of Partially Protected Composite Floors)/membrane effect. This method avoids any passive fire protection measures on secondary beams. Only beams linked to columns require protections (Figure 9.5).

Details regarding this method can be found at: [macsfire.eu](http://macsfire.eu).

Simulation of the fire itself combined with structural calculations can also be used to optimised fire protection.

For further information, ArcelorMittal has developed a "Secure with Steel Network", which is an international group of structural fire safety engineering experts, who can provide information regarding the most state-of-the-art practices. Information on this network of professionals can be found at: [sections.arcelormittal.com](http://sections.arcelormittal.com).



Figure 9.5: Fire test on unprotected cellular beams (FRACOF)



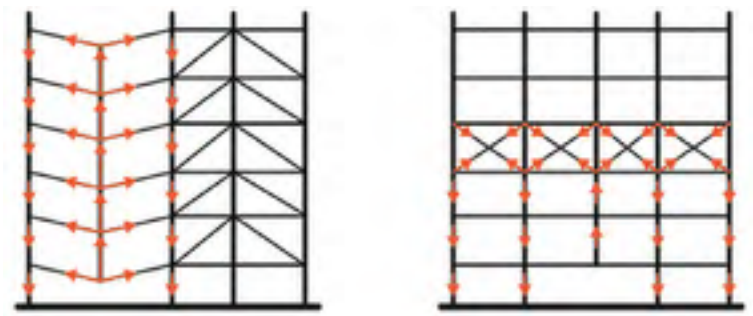

Progressive collapse resisted through tensile forces in adjacent beams

Belt truss redistribute induced forces due to column loss

**Figure 10.1 Column loss scenarios with and without belt truss systems [Eltobgy, 2013]<sup>(1)</sup> redrawn by CTBUH.**

## 10. Robustness

### • Introduction

Robustness is the capacity for a building to avoid damage that is disproportionate to the original cause of failure; such as: fire, explosion, impact or due to human errors (Eurocode 1 [CEN, 2006\*]). This design philosophy became even more prominent after the 9/11 disaster which increased the awareness about robustness of structures.

Progressive collapse is a type of disproportionate collapse related with the progressive collapse of different members because of the load redistribution coming from the failure of a single element or a limited part of a structure. In light of these considerations, the term robustness can be considered as a property of a structure, independent from the type of events that cause the collapse [Val and Val, 2006\*\*].

Structural system reliability is one of the most important concepts for building design since the scope is to minimise the probability of failure. However, this a probabilistic value since the properties and the environmental conditions are not deterministic. For these reasons risk-based methodologies are utilised [CEN, 2006\*]. Therefore, the main scope is to limit the consequences of local failure due to expected and unexpected causes.

The main design criteria for structural robustness are that, after an event, the structural system residual capacity must be bigger than the residual demand. Some of the most utilised robustness measures are: redundant elements, ductile detailing, ties, etc. [ASCE, 2010\*\*\*; CEN, 2006\*].

That means alternative load paths are to be provided in case of a member failure (e.g. column and supported beam removal or section of load bearing wall [CEN, 2006\*]).

Among all the conventional structural materials, steel can be ideal to provide robustness. Steel has several advantages compared to other structural material: very high yield strength,

ductile fracture, the capacity to work either in tension or in compression, the ability to redistribute the loads through plastic behaviour. All these properties make steel one of the best structural material for tall buildings.

### • Alternative load path method

One of the most widely used methods to test robustness is a scenario-based approach that consists in the removal of a key element in the structure to check its vulnerability. In most of the cases, column removal scenario is considered to provide an alternate load path. Critical columns should be identified and analysed with this approach. Columns are removed one by one and then the structure is analysed both statically and dynamically.

### • Superfloor systems

Progressive collapse resistance capacity of structures with megacolumns and core walls (typical of tall building systems) can be enhanced with the utilisation of outrigger and belt trusses (superfloors). The utilisation of this system can be considered as a mean for increasing robustness in a building. Outriggers and belt trusses improve continuity and interconnect with the structure, creating alternative load path to resist progressive collapse problems. Moreover, this will add redundancy to key elements, such as megacolumns. These floors will allow the distribution of the loads to all the structure in the case there is a partial collapse of an element. The connection between the core and the columns is critical to increase the robustness of the whole building. This will produce an extra-tie consideration in the building performance.

Belt truss locations can then be determined based progressive collapse requirements (as well as drifts). The idea is to locate the belt truss in a specific floor in such a way the load is distributed from the damaged area to adjacent elements. The ideal location of the belt truss is as close as possible to the removed column as shown by Figure 10.1.

\* CEN, 2006. Eurocode 1: Actions on Structures – Part 1-7: General Actions – Accidental Actions. ENV 1991-1-7:2006. European Committee for Standardisation.

\*\* Val, D.V., and Val, E.G., 2006. Robustness of Frame Structures. Structural Engineering International, 16(2), 108-112.

\*\*\* ASCE, 2010. ASCE 7-10: Minimum Design Loads for Buildings and Other Structures. American Society of Civil Engineers.

<sup>(1)</sup> Eltobgy, 2013: Eltobgy Hanan, Optimum belt truss locations to enhance the structural performance of high-rise steel buildings, WULFENIA Journal, Klagenfurt, Austria, Vol 20, No. 6, Jun 2013.

"HISTAR®/ASTM A913 material has enabled Walter P Moore to extend our reach in providing high-strength seismic systems in the most challenging locations. Grade 65 material, which is permitted for columns in ductile seismic systems, has enabled us to be more efficient and more effective in designing structures to withstand the most intense seismic motions."

**Rafael Sabelli, S.E.**

Principal, Director of Seismic Design

**WALTER P MOORE**

San Francisco, USA

## 11. Earthquake design

Earthquake refers to the earth shaking with a sudden release of energy that creates seismic waves. These events are mainly caused by the rupture of geological faults, but other possible sources are volcanoes and landslides. The point of rupture is called the hypocenter and the point directly above it on the ground is called the epicenter. Usually, the most significant earthquakes are located close to the borders of the main tectonic plates which cover the surface of the globe (Figure 11.1). These plates tend to move relative to one another but are prevented from doing so by friction until the stresses between plates under the epicenter point become so high that a move suddenly takes place. The local shock generates waves in the ground which propagate over the earth's surface, creating movement at the bases (foundations) of structures. The size of the waves reduces with the distance from the epicenter. Therefore, there are regions of the world with high seismic risk, mainly depending on their proximity to the boundaries of the main tectonic plates.

The action applied to a structure by an earthquake is a ground movement/acceleration with horizontal and vertical components (Figure 11.2). The vertical component of the earthquake is usually about 50% of the horizontal component, except near the epicenter where it can be of the same order. Today, minimum building requirements are that structures are designed to withstand these loads without collapse. However, stringent criteria are usually taken into consideration to reduce damage to the building thus, reducing injuries. This approach is called performance-based design and requires a structure to be designed to achieve higher performance objectives (Figure 11.3). Performance-based design also allows projects to overcome code limitations and to utilise structural systems that are not prescribed by code (such as outriggers and belt trusses, see **CTBUH Performance Based Seismic Design Technical Guide** for more details). Three different levels of intensity are considered by this method: Maximum considered Earthquake



Figure 11.1: World map showing the main tectonic plates. From Bristol University website: [www.ideers.bris.ac.uk](http://www.ideers.bris.ac.uk)

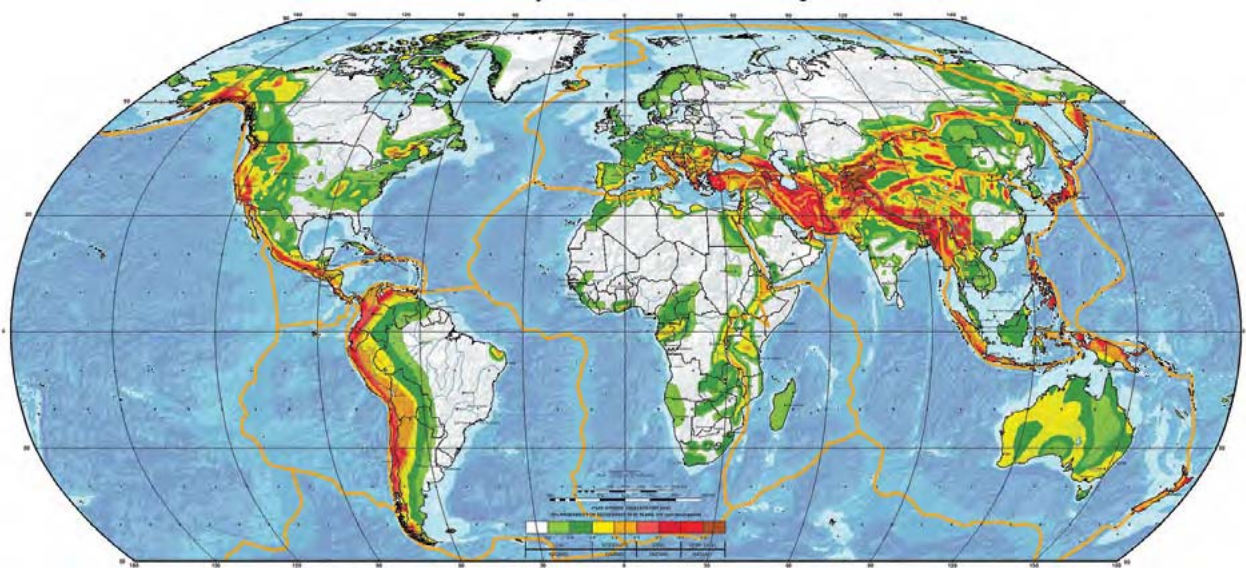
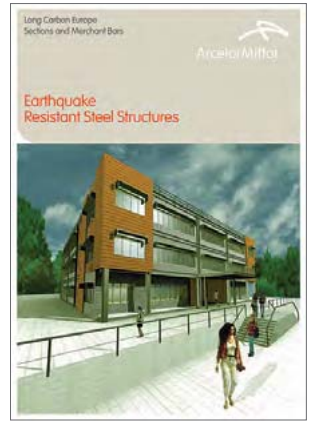
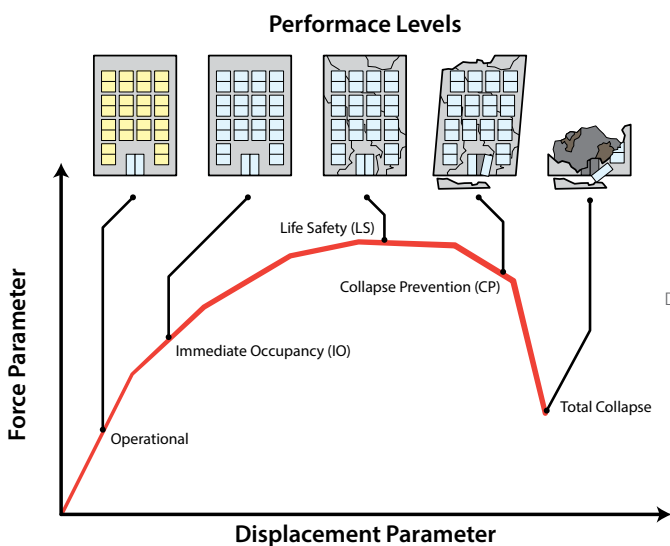

**Figure 11.2: Global seismic hazard map, 1999**

[produced by the Global Seismic Hazard Assessment Program (GSHAP), a demonstration project of the UN/International Decade of Natural Disaster Reduction, conducted by the International Lithosphere Program. Global map assembled by D. Giardini, G. Grünthal, K. Shedlock and P. Zhang.]

(MCER), Design Earthquake (DE) and Service Level Earthquake (SLE). Furthermore, the acceptable performance levels are defined as: operational, immediate occupancy,

life safety and collapse prevention. The possible relationship between performance level and earthquake intensity at various risk category levels as given in Figure 11.4.



**Figure 11.3 Structural Performance Objectives**



**Figure 11.4. Performance Levels of Code-Based Buildings at Various Risk Category Levels**



Means to resist earthquake actions are commonly based on two different approaches:

- Option 1: structures made of sufficiently large sections that they are subject to only elastic stresses.
- Option 2: structures made of smaller sections, designed for ductility (i.e. for inelastic behaviour without strength degradation). In this case, the designer accepts some level of damages to occur in the structural and non-structural elements.

A structure designed to option 1 will be heavier and may not provide a safety margin to cover earthquake actions that are higher than expected, as element failure is not ductile (i.e. low robustness). In this case, the structure's global behaviour is 'brittle'. One example could be a "soft" first storey as shown in 'Concept a' in Figure 11.5. In this case, the building response is not safe since the first inelastic deformations due to the seismic demands are developing on the first-floor columns. However, these columns are not designed to undergo these inelastic deformations (no energy dissipation due to cyclic behaviour), and therefore, as the demands increase, the deformations also increase accordingly. This would lead to first floor column failure inducing generally total building collapse.

In a structure designed according to option 2, selected parts of the structure are intentionally designed to undergo

cyclic plastic deformations without failure, and the structure is designed such that only those selected zones (plastic hinges) will be plastically deformed (as shown in Figure 11.6). The structure's global behaviour is 'ductile' and in this way it can dissipate a significant amount of energy through the formation of globally distributed plastic hinges (as shown in "Concept b" in Figure 11.5). For these reasons, the two design options are said to lead to 'dissipative' and 'non-dissipative' structures, respectively.

Experience shows that steel structures subjected to earthquakes behave well. Severe damages and collapses are mostly associated with structures made from other materials. This may be explained by some of the specific features of steel structures, such as: high ductile and stable hysteretic behaviour under cyclic loading. One of the most common solutions to obtain a ductile behaviour is the utilisation of the strong column – weak beam concept. If this solution is adopted, the inelastic deformations are forced to happen in the beam and not in the column. This would lead to a more ductile behaviour reducing the risk of collapse. The idea of this concept was at the base on the work conducted in 1989 by ArcelorMittal that developed (and patented) a Reduced Beam Section (RBS) or "dog-bone" connection (Figure 11.6 to 11.8). This connection can be

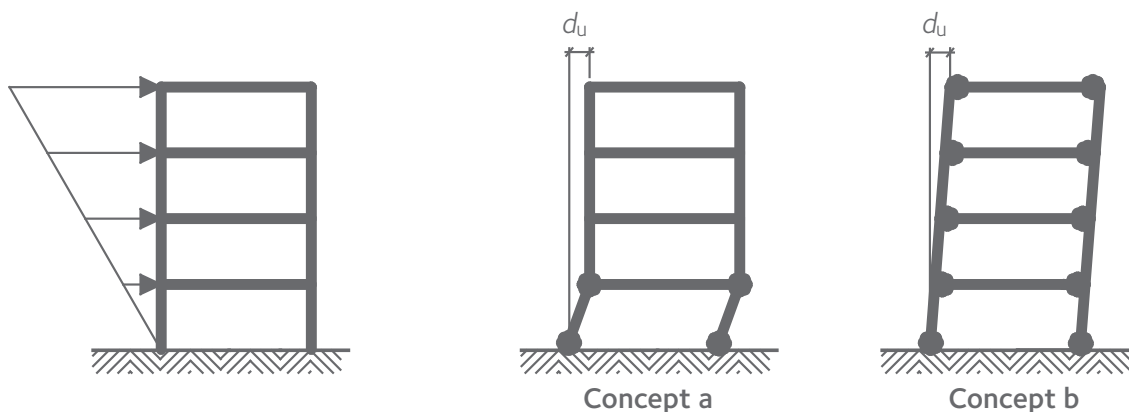

**Figure 11.5: Examples of 'Dissipative' and 'Non-Dissipative' global behaviours of structures. "Non-dissipative" structure fails in a soft single storey mechanism**





**Figure 11.6: RBS: Reduced Beam Section Plasticisation**



**Figure 11.7: Reduced beam**

easily developed in the fabrication shop and results in the removal of a portion of the beam's flange material at its connection to supports. Design of such a connection became more critical after the 1994 Northridge earthquake, which exposed several seismic design deficiencies. Several steel moment frame buildings experienced brittle fractures of beam-to-column connections because of the earthquake. The SAC Joint Venture, under contract by FEMA, studied the "strong column - weak beam" design concept (Figure 11.8). When used in conjunction with ArcelorMittal's RBS connection, which was released from patent in 1995, this design concept can facilitate a shift of the plastic deformation from the column to the beam during an earthquake, thereby preventing the connection between the column and the beam from experiencing inelastic deformations. The method was successfully tested by AISC and was included in the FEMA 350 and 353 documents.

Because of these research projects, the construction industry shifted away from ASTM A36 to Grade 50 steel. Moreover, for ductility purposes, it is often necessary to use higher strength steel in the design of columns. Using ASTM A913 Grades 65 or 70 for column shapes and A913 Grade 50 (with a maximum yield point of 65 ksi) for beams, coupled with the RBS, offers the most economical solution to seismic design available today. In addition, replacing A992 with higher

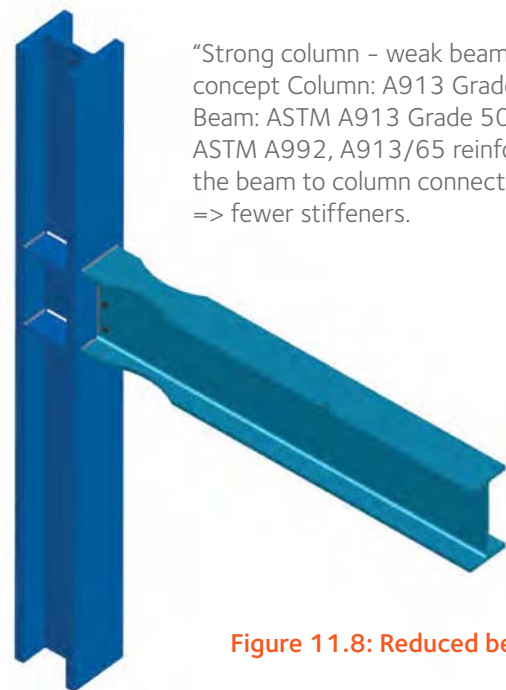

"Strong column - weak beam" concept  
 Column: A913 Grade 65  
 Beam: ASTM A913 Grade 50 -  
 ASTM A992, A913/65 reinforces  
 the beam to column connection  
 => fewer stiffeners.

**Figure 11.8: Reduced beam**

yield A913 can lower material weight and cost, strengthen connections, reduce or eliminate stiffeners in the panel zone and reduce or eliminate the need for double plates (Figure 11.8). Prequalified joints for earthquake resistance as defined in the American code cover almost the whole range of ArcelorMittal sections (see chapter 7, page 46).

*HISTAR® steel: only ~600 kg CO<sub>2</sub>/tonne*

according to the Environmental Product Declaration



## 12. Sustainability of Steel

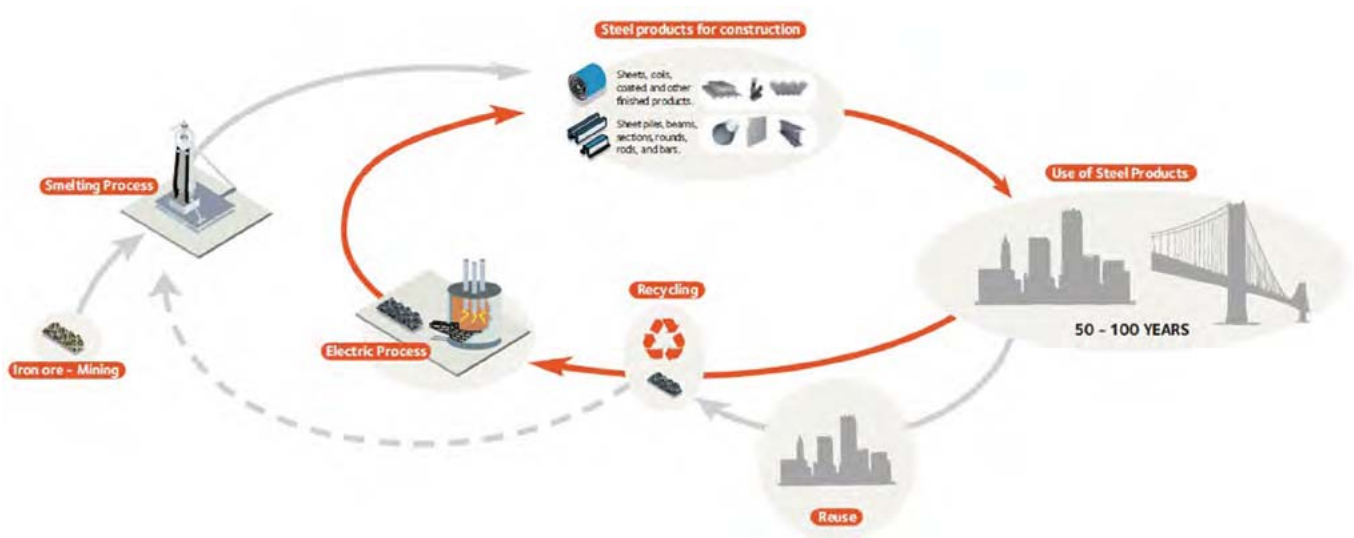

**Figure 12.1: 1,2 tonnes of steel recycled by ArcelorMittal each second**

Steel can be indefinitely recycled without any loss in quality. This means that the amount of scrap material from job sites or manufacturing plants, in addition to steel elements recovered from demolished building and structures, contribute to most of the steel material used in new high-rise structures (Figure 12.1). Steel is the most recycled material in the world.

About 65–70% of all steel needed for reinforcement bars has come from recycled material and 99% of steel beams are developed from recycled steel (approximately 88% recycled and 11% can be reused)\*. Recycled steel represents currently about 40% of the steel industry's ferrous resource in the world. With 33 million tonnes of CO<sub>2</sub> saved each year, ArcelorMittal is the world's largest recycler of steel.

Furthermore, ArcelorMittal is striving to reduce the overall environmental impact in the manufacturing process. Waste generation, water use, and air emissions are continually decreasing, as are energy consumption and greenhouse gas emissions. The European steel industry is one of the most

efficient steel industries in the world. European steelmakers have reduced energy consumption and CO<sub>2</sub> emissions per tonne of steel by 50% since 1960 and are now close to the technically feasible minimum\*\*. ArcelorMittal production sites of beams have all reached ISO 14001 certification, the international standard for environmental management systems.

In addition, these sites are BES 6001 certified (Responsible Sourcing). ArcelorMittal is also a proponent for a dry steel construction system and using prefabricated steel elements during construction. This can lead to a shortened total construction time and reduce various risks during the construction phase, as assembly is simpler, and less labour is required. Using prefabricated elements also reduces physical environmental impacts to the surrounding land and neighbourhood nuisance. Water use, waste generation, dust emission, traffic, and noise are considerably lower than in traditional construction. Work site management is largely facilitated. All these advantages are especially valuable for congested urban areas.

*"Sustainability has clearly become a major driver of change in tall building development..."*

according to "Life Cycle Assessment of Tall Building Structural Systems"

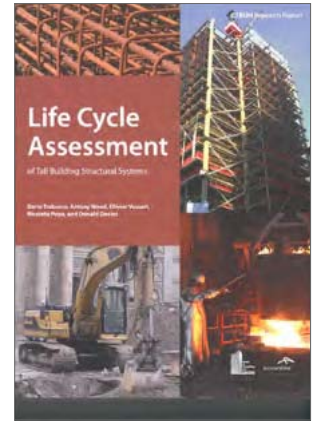

- Life Cycle Assessment

Developed during the 1990's, Life Cycle Assessment (LCA) is a methodology aimed at assessing the environmental consequences of human actions, particularly in the production of goods. In the past two decades, LCA analysis has become more and more popular in all disciplines, especially in architecture and engineering. LCA has been used for thousands of research projects analysing the environmental characteristics of materials, components and even entire buildings.

Based on the International Reference Life Cycle Data System Handbook (JRC, 2010)\*, a handbook released by the European Union's Joint Research Centre, Institute for Environment and Sustainability, The Council on Tall Buildings and Urban Habitat, in collaboration with ArcelorMittal, produced Life Cycle Assessment of Tall Building Structural Systems, which analysed tall building structures from their inception to demolition. A complete description of the research programme, including detailed information on the individual studies that were performed, can be found at <https://store.ctbuh.org/research-reports/48-life-cycle-assessment-2015.html>.

- Global Warming Potential and Embodied Energy  
Due to climate changes that have occurred in recent years because of greenhouse gas emissions, many efforts in the tall building industry are focused on reversing this trend. Global Warming Potential (GWP) and Embodied Energy (EE) are indicators to give a general sense of the consequences building materials can have on environmental sustainability.

Energy is the driving force of life on earth, and the cause of many political, military, and strategic decisions internationally. Acknowledging the importance of energy broadens the definition of "sustainability" to account for the social and economic implications of energy consumption beyond purely environmental considerations.

However, energy is profoundly linked to environmental aspects too, as the use of fossil fuels and other non-renewable resources induces large emissions of CO<sub>2</sub> and other greenhouse gasses (Trabucco, et al., 2015)\*\*.



\* JRC, E. C. J. R. C. (2010) "ILCD Handbook: International Reference Life Cycle Data System" (First Edition)

\*\* Trabucco, D., Wood, A., Popa, N., Vassart, O. & Davies, D. (2015) Life Cycle Assessment of Tall Building Structural Systems. Council on Tall Buildings and Urban Habitat: Chicago.

- Steel structure performances

To verify the sustainability of steel as a structural product, 60-storey tower scenarios were developed for different structural arrangements.

In this analysis, all-concrete solutions performed worse (on average) than the other scenarios that used steel, in terms of GWP (Figure 12.2).

Consequently, each tall building scenario can benefit from the recyclability of the steel at the end of the building life cycle along varying magnitudes: concrete scenarios benefit from the recyclability of rebar, while steel buildings benefit from

the recycling potential of the majority of the structural material, including steel sections, rebar, steel decks, etc.

Following the in-depth analysis, it was found that some of the environmental impacts occur during the final delivery of the materials to the construction site. Most of the environmental impact comes from the direct delivery of the structural materials to the constructions site through the use of diesel-powered trucks. When structural materials are shipped internationally, they are traditionally shipped in bulk with ships, barges, trains, etc. This method, although over a

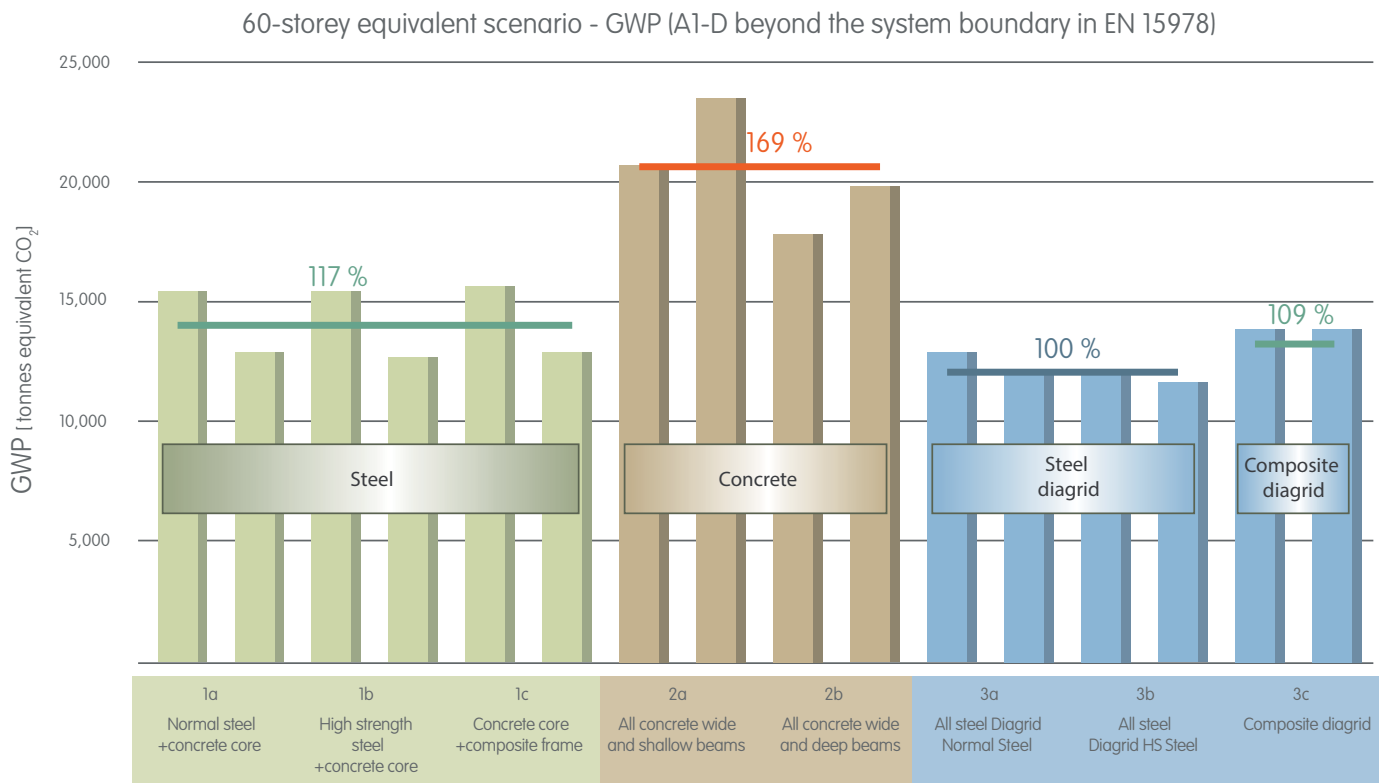

Figure 12.2: LCA of the 60-storey Scenarios Global Warming Potential (CO<sub>2</sub>)





versus



avg 1.7% in terms of GWP  
avg 1.9% in terms of EE

avg 5% in terms of GWP  
avg 6.3% in terms of EE

**Figure 12.3: Environmental effect of transport**

larger distance, does not contribute to significantly more total GWP and EE, when compared the manufacturers that may be closer to the construction site itself (Figure 12.3).

Furthermore, transportation of both construction materials to the site and transportation of demolition material and waste off sites does not account for a significant amount of the total GWP (between 1 and 2,5%) or the total EE (between 0,9 and 3,2%). This means that, in some cases, it is more important to find producers of high-quality, efficient structural material for a successful project, regardless of their distance from the construction site.

Significant environmental benefits can be realised by choosing

the best material production process, as the same material can have profoundly different environmental properties, depending on the source. For example, steel products produced in ArcelorMittal's Differdange location, such as ASTM A913 profiles are made with predominantly recycled steel scrap, using electric arc furnaces. The environmental properties of such products are less impactful than other conventional building materials (see EPD leaflet for Histar® steel page 58: **Environmental Product Declaration**).

Also, the structures designed with these materials have a significantly lower GWP and EE than structures designed with the average environmental values published by WorldSteel (WorldSteel Association 2011)\* (Hammond & Jones 2011)\*\*.

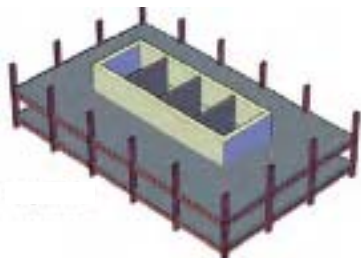

*Steel Frame with Concrete Core*

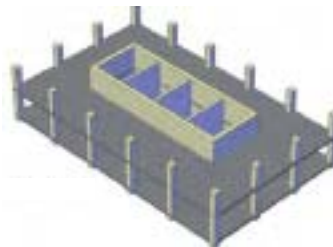

*Concrete Structure*

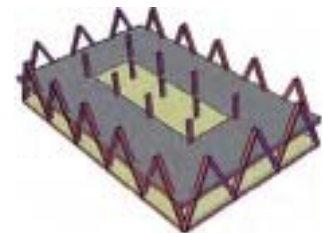

*Steel Diagrid Structure*

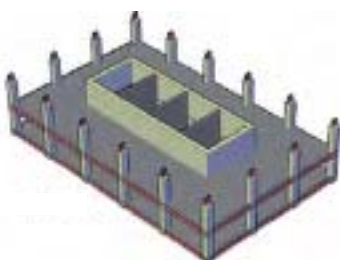

*Composite Structure*

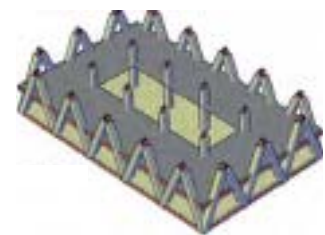

*Composite Diagrid Structure*

\* Worldsteel Association (2011) "Life Cycle assessment methodology report" Worldsteel Association, Brussels, Belgium.

\*\* Hammond, G. & Jones, C. (2011), "Inventory of Carbon and Energy (ICE) Version 2.0", Claverton Down: University of Bath.

## 13. Reference projects

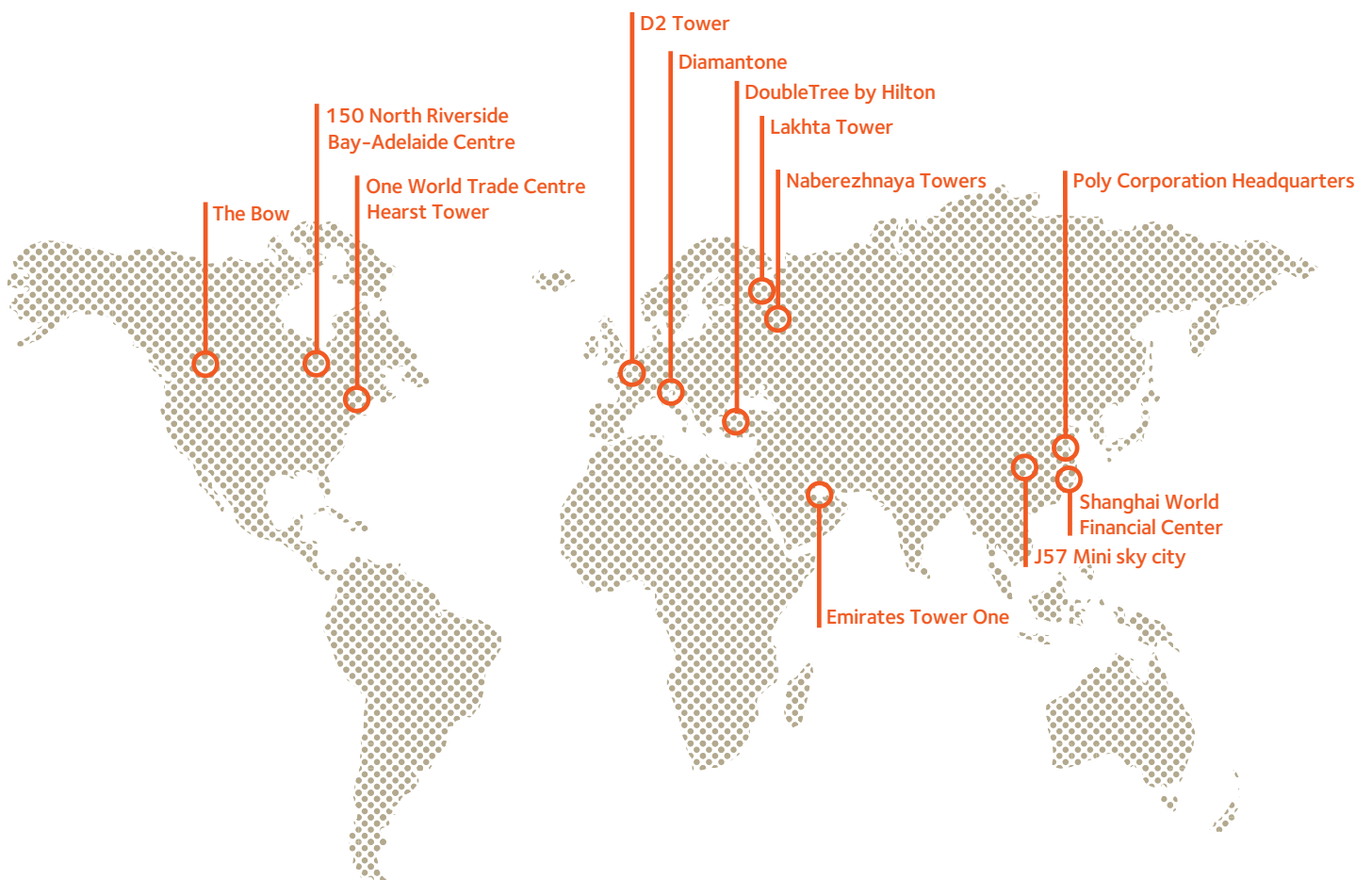

### Europe

- D2 Tower – Paris, France
- Naberezhnaya Towers – Moscow, Russia
- Diamantone – Milan, Italia
- DoubleTree by Hilton – Istanbul, Turkey
- Lakhta Center – St. Peterburg, Russia

### Asia

- Emirates Tower One – Dubai, UAE
- J57 Mini sky city – Changsha, China
- Poly Corporation Headquarters – Beijing, China
- Shanghai World Financial Center – Shanghai, China

### America

- Hearst Tower – New York, USA
- The Bow – Calgary, Canada
- One World Trade Center – New York, USA
- 150 North Riverside – Chicago, USA
- Bay-Adelaide Centre – Toronto, Canada

The following Projects are outstanding skyscrapers where **ArcelorMittal products and solutions** have been used and have contributed to an optimum structural efficiency.

**The Skyscraper Center**  
The Global Tall Building Database and Research Center

**ArcelorMittal**  
Acquired Arcelor (2006)  
Acquired Mittal Steel (2006)  
Parent company of Arcelor S.A.

Click a company above to see buildings specifically involving that company. The building list below shows buildings involving ArcelorMittal, Arcelor, Mittal Steel, Arcelor S.A., Arcelor, Arcelor, Mittal Steel Group, International Steel Group, Ispat International S.A.

**Buildings**  
Note: All listed data for completed or under construction buildings is based on the most reliable information currently available. This data is not subject to change until the building has completed and all information has been confirmed and certified by the CTBUH.

Legend: Completed, Anticipately Topped Out, Brumantly Topped Out, Under Construction, On Hold, Never Completed, Proposed, Under, Discontinued

#	Building Name	City	Height (m)	Height (ft)	Floors	Completed	Status	Use
1	Two World	St Louis (MO)	328	1,076	103	2010	Completed	office / residential / hotel
2	One World Trade Center	New York City (NY)	541.3	1,778	104	2011	Completed	office
3	Pentagon One	St Louis (MO)	198	650	42	-	Completed	residential
4	Three World Trade Center	Washington (DC)	442	1,450	101	2023	Proposed	hotel / office

**ArcelorMittal on the Skyscraper Center:**  
<http://www.skyscrapercenter.com/company/7007>

Some high-rise buildings with HISTAR® or ASTM A913 steel grades

Projects America	Location
33 ARCH STREET	BOSTON, MA
111 HUNTINGTON	BOSTON, MA
EIGHTH AVENUE PLACE	CALGARY, AB
THE BOW	CALGARY, AB
MANULIFE TOWER*	CALGARY, AB
111 SOUTH WACKER	CHICAGO, IL
ONE SOUTH DEARBORN	CHICAGO, IL
300 NORTH LASALLE	CHICAGO, IL
150 NORTH RIVERSIDE*	CHICAGO, IL
155 WACKER	CHICAGO, IL
LURIE HOSPITAL	CHICAGO, IL
HARTFORD 21 / TOWN SQUARE	HARTFORD, CT
LAS VEGAS CLUB TOWER	LAS VEGAS, NV
COSMOPOLITAN	LAS VEGAS, NV
TORRE REFORMA 509	MEXICO, ME
BRICKELL CITY CENTER	MIAMI, FL
250 WEST 55 <sup>th</sup> STREET	NEW YORK, NY
ONE WORLD TRADE CENTER	NEW YORK, NY
THREE WORLD TRADE CENTER	NEW YORK, NY
FOUR WORLD TRADE CENTER	NEW YORK, NY
217 WEST 57 <sup>th</sup> STREET*	NEW YORK, NY
425 PARK AVENUE*	NEW YORK, NY
HUDSON YARDS	NEW YORK, NY
4 TIMES SQUARE	NEW YORK, NY
HEARST TOWER	NEW YORK, NY
STANDARD HOTEL	NEW YORK, NY
300 MADISON AVENUE	NEW YORK, NY
PHELPS DODGE TOWER	PHOENIX, AZ
ADVANCED EQUITIES PLAZA	SAN DIEGO, CA
BROADWAY 655	SAN DIEGO, CA
555 MISSION STREET	SAN FRANCISCO, CA
RUSSEL INVESTMENTS CENTER	SEATTLE, WA
5 <sup>th</sup> & COLUMBIA	SEATTLE, WA
BAY ADELAIDE CENTER*	TORONTO, ON
BROOKFIELD PLACE*	TORONTO, ON

Projects Europe	Location
REMBRANDT TOWER	AMSTERDAM, NL
TORRE MAPFRE	BARCELONA, ES
THE PINNACLE	LONDON, UK
25 CHURCHILL PLACE	LONDON, UK
DIAMOND OF ISTANBUL	ISTANBUL, TR
HILTON DOUBLETREE HOTEL	ISTANBUL, TR
PUERTA DE EUROPA	MADRID, ES
TORRE REPSOL	MADRID, ES
TORRE DE CRISTAL	MADRID, ES
TORRE BANKIA	MADRID, ES
DIAMANTONE	MILANO, IT
DESIO TOWER	MILANO, IT
NABEREZHNYA TOWER	MOSCOW, RU
FEDERATION COMPLEX	MOSCOW, RU
EMBANKMENT TOWER	MOSCOW, RU
EURASIA TOWER	MOSCOW, RU
IMMEUBLE BASALTE	PARIS, FR
D2 TOWER	PARIS, FR
LAKHTA TOWER	ST PETERSBURG, RU
DAEWOO TOWER	WARSAW, PL

Projects Asia	Location
POLY CORPORATION HEADQUARTERS	BEIJING, CN
J57 MINI SKY CITY	CHANGSHA, CN
EMIRATES TOWER ONE	DUBAI, UAE
PENTOMINIUM TOWER	DUBAI, UAE
TRUMP TOWER	MUMBAI, IN
CMA TOWER	RIYADH, SA
SHANGHAI WFC	SHANGHAI, CN

\*using ASTM A913 Grade 70



Europe

Height: 171m (561ft)  
 Number of Floors: 36  
 Gross floor area: 54 500m<sup>2</sup>  
 Building Function: Office  
 Structural material: Steel columns and beams with composite floors and a reinforced concrete core  
 Completion: 2014  
 Architect: Agence d'architecture Anthony Béchu – Tom Sheehan  
 Structural Engineer: DVVD; Setec TPI  
 General Contractor: GTM Bâtiment (Vinci group)  
 ArcelorMittal Steel: 3 000 tonnes of HD 400 sections in HISTAR® 460 and 1 200 tonnes of ACB® beams  
 Fabricator: lemants

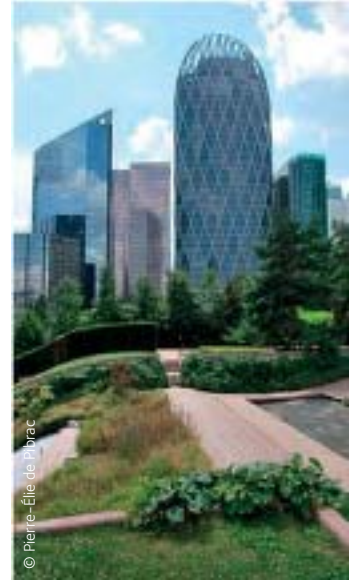

## D2 Tower (Paris, France)

**Project Overview:** To answer the specific needs for the construction of the D2 Tower, ArcelorMittal supplied 50,000 m<sup>2</sup> of steel for the composite floor deck and 4 200 tonnes of structural steel and beams. Designed in the large urban renewal project of La Défense, the D2 Tower, inaugurated in January 2016, is the first high rise building in France with an external steel grid structure.

Building systems	Steel Solutions	ArcelorMittal Solutions			Fire resistance
		Heavies	High strength steel	Finished beams	
 Bracing Columns		diagrid	HISTAR® 460		sprayed + protective metal coating
		internal columns	HISTAR® 460		sprayed/Intumescent coating
Floor solutions			cellular beams	cellular beams	sprayed

### • Steel Structure

The perimeter diagrid consists of large and heavy, hot rolled steel sections, mainly HD 400, in HISTAR® 460 steel grade, allowing interesting 30% weight reduction and about 25% cost decrease for the steel needed for the building structure. Mainly 12m long sections were assembled on site in a V-shape, each weighing about 14 tonnes. Each V covers the height of 3 floors and is integrated into the curtain wall of different sized and shaped glazed elements. The ACB® beams' circular openings in the web simplified the layout of the technical installations and an increased usable floor height.

### • HISTAR® 460 & ACB® beams

ArcelorMittal Europe – Long Products provided 4,000 tonnes of structural steel, thereof 3 000 tonnes of HISTAR® 460 sections for the diagrid and 1 200 tonnes of ACB® beams. To note that hot rolled sections in high strength steel grades are produced by few mills on the market and ArcelorMittal Differdange is the only one capable to offer HISTAR® grades.

ArcelorMittal Construction France also contributed to this project, providing 50 000 m<sup>2</sup> of Cofraplus® 60, composite steel decking for the floors. Chosen for its light weight and high strength, it combines the performance of a galvanized steel profile with that of reinforced concrete. The ACB® beams between the external structure and the concrete core support the Cofraplus® 60 floor deck.

### • Shortening construction time

Thanks to the steel structure the weight of the tower was significantly reduced compared to a concrete structure. The steel structure reduced the overall costs, shortened the construction time, allowed a faster occupancy and return on the investment.

Overall, the use of a composite flooring system and cellular floor beams increased the total usable floor area and allowed the construction to be time efficient: according to time schedule and budget, the construction could be carried out at a steady rate of 3 floors in 3 weeks.





Europe

Height: 268,4m (881ft)  
 Number of Floors: 61  
 Gross floor area: 136 651m<sup>2</sup>  
 Building Function: Office  
 Structural material: Steel perimeter framing and outriggers with composite floors a reinforced concrete core  
 Completion: 2007  
 Architect: ENKA Design; RTKL  
 Structural Engineer: ENKA Design; Thornton Tomasetti  
 General Contractor: ENKA  
 ArcelorMittal Steel: 13 500 tonnes in HISTAR® 460 for Russian weather conditions  
 Fabricator: ENKA



## Naberezhnaya Towers (Moscow, Russia)

**Project Overview:** Located on plot 10 of the Moscow International Business Centre (MIBC), the Naberezhnaya Towers are an office complex consisting of 3 individual office buildings, interconnected at the basement levels. Block C, the tallest of the three towers at a height of 268,4 meters, achieved the status of the “Tallest Building in Europe” at the time of completion in 2007, before being surpassed by the Capital City Moscow Tower in 2010. The complex includes shops, a restaurant and the connecting central core public area. Vestibules, reception groups and administrative rooms are on the ground and mezzanine floors. Open-plan offices extend from the 2<sup>nd</sup> to the 58<sup>th</sup> floors.

Building systems	Steel Solutions	ArcelorMittal Solutions			Fire resistance
		Heavies	High strength steel	Finished beams	
Bracing		outriggers trusses with concrete core	HISTAR® 460 for Russian weather conditions		sprayed
Columns		perimeter columns			4 hours concrete encasement
Floor solutions				composite beams	sprayed

- Steel Structure

The majority of the structure consists of steel perimeter columns and composite floor systems with a cast-in-place reinforced-concrete central core. Built-up steel box columns are arranged at the tower's perimeter to resist only vertical loads and avoid directly transferring lateral loads. At the 26<sup>th</sup> and 59<sup>th</sup> floors, outrigger and belt trusses were installed; the outriggers were designed between the core and perimeter columns to restrict lateral displacement of the core under wind effects and the belt trusses were installed between the perimeter columns to distribute the lateral loads that are transferred by outriggers. This structural solution ensures that the maximum allowable lateral drift at the top of the building is limited to only 0,2% of its height.

- HISTAR® 460

The Naberezhnaya Towers are the first projects to use a special high strength steel produced by ArcelorMittal (HISTAR® 460 for Russian weather conditions). Extensive tests were conducted to ensure that the toughness of the steel, even under the extreme Russian weather conditions of -20°C, still provided adequate structural performance.

- Fire Resistance

Highly effective fireproof compounds with a certified fire safety performance are applied to the surface of the 13 500 tonnes of structural steelwork. The fire protection of the steel columns has been ensured by concrete encasement, which can achieve at least four hours of fire resistance for the steel structure.



Europe

Height: 140m (459ft)  
 Number of Floors: 31  
 Gross floor area: 290 000m<sup>2</sup>  
 Building Function: Office  
 Structural material : Steel columns with composite floors a reinforced concrete core  
 Completion: 2012  
 Architect: Kohn Pedersen Fox Associates Pc  
 Structural Engineer and Work Supervisor's technical support: ARUP  
 General Contractor: ATI CMB/UNIECO  
 ArcelorMittal Steel: 3 800 tonnes  
 Fabricator: StahlBau Pichler in Bozen/Bolzano



© Lorenzo de Simone

## Diamantone (Milan, Italy)

**Project Overview:** Located in the Centro Direzionale di Milano, a major business district in Milan, the 140-meter Diamantone or Diamond Tower, became the tallest steel structure in Italy, and the country's third tallest building, when it was completed in 2012. Diamantone, named for its irregular, faceted form that references a diamond, is the tallest of the three towers built on this plot, with the additional two buildings known as the Diamantini or the Small Diamonds. They were constructed as part of the extensive urban redevelopment program in Milan, known as the Progetto Porta Nuova.

Building systems	Steel Solutions	ArcelorMittal Solutions			Fire resistance
		Heavies	High strength steel	Finished beams	
 Bracing		concrete core			sprayed
 Columns		perimeter column:HD360/HD400	S460M		sprayed /board
Floor solutions			S355	composite beams	sprayed

### • Steel Structure

Designed with steel columns, composite flooring, and a reinforced concrete core, the building is lighter than a conventional reinforced concrete structure. High strength steel was used in the structure, which has a higher yield strength compared to conventional, S235 grade steel. This resulted in up to a 50% reduction in the total material cost. Since the cost of the S460 M grade rolled sections is just 10-15 % higher than S235 grade material, 30-40% of the savings could be achieved exclusively in the material costs.

It also allowed column-free office space, enabling a preferential shallow foundation and providing significant advantages in terms of transportation of materials on-site.

The additional savings were achieved through a reduction in the amount of welding material, corrosion protection and transportation costs using less structural material and less surface area.

### • Arcelormittal Steel Sections

The composite beams provided for Diamantone, were S355 grade, IPE and HE sections that contain several openings in the web for the integration of building services and can achieve spans of up to 11 meters. 1 800 IPE and HE composite floor beams were provided, with a total combined length of 13 520 meters. The steel deck of the composite floors had an undercut geometry that contributed to the reinforcement, allowing for a floor thickness of only 15-20cm. A total of 26 000m<sup>2</sup> of composite decking was used.

### • Avoiding traffic impact

The challenges of a major construction project in a dense urban environment includes heavy traffic, reduced space for unloading, and virtually no storage space. Through a detailed production and logistics plan, the 3 800 tonnes of steel elements were delivered in 150 separate loads with limited interruptions to regular traffic and only 2 deliveries a day. Through these sustainable and efficient design and construction methods, Diamantone achieved a LEED Gold certification, one of the highest ratings recognised by the Green Building Council.



Europe

Height: 110m (361ft)  
 Number of Floors: 27  
 Gross floor area: 25 042m<sup>2</sup>  
 Building Function: Hotel  
 Structural Material: Steel with reinforced concrete at basement levels  
 Completion: 2012  
 Architect: Uras x Dilekci Architects  
 Structural Engineer: Yapı Teknik  
 General Contractor: Gülermak  
 ArcelorMittal Steel: 2000 tonnes  
 Fabricator: Gülermak



Sonkar Oto

## DoubleTree by Hilton (Istanbul, Turkey)

**Project Overview:** Located in Avclar, a district in Istanbul, Turkey, the 110-meter DoubleTree by Hilton became the tallest all-steel building in Turkey when it completed in 2012. It was bestowed the “Best Steel Structure High-Rise Building” award by TUSCA in 2013. Originally envisioned as a 14-floor steel and glass auto showroom, the design quickly shifted to 27-floor hotel building that includes an indoor pool, fitness and business centres and restaurants.

Building systems	Steel Solutions	ArcelorMittal Solutions			Fire resistance
		Heavies	High strength steel	Finished beams	
 Bracing		steel frame	HISTAR® 460		Intumescent coating
	Columns	perimeter columns	HISTAR® 460		Intumescent coating
Floor solutions			S355 primary beams	composite beams	Intumescent coating

### • Steel Structure

Steel was chosen as the primary structural material, due to the high amount of seismic activity in the area. Furthermore, as the function and size of the tower changed during the construction process, steel columns reinforced with cast-in-place concrete were used in the basement and an overall refurbishment of the foundation was conducted. This gave the foundation the ability to accommodate the increased stress on the system, without sacrificing the construction work that had already occurred; this is another aspect of this project that could not have been achieved without the use of steel. The primary structure consists of HISTAR® HD columns with a 40 x 40cm cross-section. These columns can accommodate all the vertical loads and all horizontal loads, from earthquakes and wind, are supported by transverse bracing elements, which are also HISTAR® HD columns. The use of steel for the primary structure, instead of reinforced concrete, also allowed for a smaller worksite (only the backyard and parking lot were used), minimising the impact on the surrounding environment. Furthermore, the use of steel also contributed aesthetically to the design; the thin structural elements help provide the maximum views towards the Sea of Marmara and the Lake of Kucukcekmece.

### • HISTAR® 460 Jumbo columns

A total of 2 683 tonnes of steel was imported on site. All deliveries of the ready-to-erect steel occurred during the night times, which minimised disturbances to the surrounding area and interruptions in regular traffic. HISTAR® 460 Jumbo columns, S355 primary beams and bracing, and S275 secondary beams were used to assemble the structure, due to their flexibility and weldability. The column joints were prepared so that full penetration butt welds could be achieved on-site. The main beams and secondary beams were designed as composite floor elements, coated in concrete, which was an economic and efficient solution, in terms of the increased spans that were able to be achieved, the minimal amount of material used, and the reduced floor thicknesses. All beam-to-beam and column-to-beam connections were achieved using high-strength 10-grade steel bolts.

### • Fire Resistance

In order to achieve adequate fire resistance, all steel sections were coated with an intumescent coating. This was also used due to its aesthetic value, as the bracing elements are exposed in the hotel rooms, and the paint provides a clean, modern finish.



Europe

Height: 462m (1 516ft)  
 Number of Floors: 87  
 Gross floor area: 163 000m<sup>2</sup>  
 Building Function: Office  
 Structural Material: Composite columns and floors with steel-braced reinforced  
 Completion: 2018 concrete outriggers and a reinforced concrete core  
 Architect: Gorproject; RMJM  
 Structural Engineer: Gorproject; Inforceproject  
 General Contractor: Renaissance Construction Company  
 ArcelorMittal Steel: 18 309 tonnes in HISTAR® 460 Russia  
 Fabricator: CIMOLAI, NTZMK, BELENERGOMASH, CZMK, ZZMK, Kurganstalmost



## Lakhta Center (St. Petersburg, Russia)

**Project Overview:** Located in the Primorsky district of St. Petersburg, the Lakhta Center will create a sustainable economic zone by combining the office space of the tower with transportation infrastructure, green space, and several public resources, including a planetarium, sports complex, medical centre, performance hall and a bank. The tower will be the headquarter of Gazprom, the world's largest gas company.

Building systems	Steel Solutions	ArcelorMittal Solutions			Fire resistance
		Heavies	High strength steel	Finished beams	
 Bracing		concrete core + steel frame + outriggers	HISTAR® 460 Russia		composite
 Columns		composite mega-column	HISTAR® 460 Russia	cruciform columns	composite
Floor solutions				composite beams	sprayed

### • HISTAR® 460

The structural frame of the tower's star shaped cross-sectional footprint, slightly different on every floor, features at its centre a circular core in concrete housing mainly the elevators. The tower's 73 000 m<sup>2</sup> facade is formed from 16 500 pieces of glass. At its perimeter, the structure rests on steel-composite-columns made of structural sections in quality steel HISTAR® 460 Russia. This high-performance steel grade allowed relevant cost savings in the programme, by optimising the weight and time to process and install.

The heavy H-sections were processed by cutting into T-sections to make cruciform shaped column profiles, which were subsequently encased in concrete. For the construction of the tower and the two multi-functional buildings, ArcelorMittal Europe – Long Products' mill in Differdange (Luxembourg) delivered 21 254 tonnes of steel sections, that includes processing. Differdange mill is the only plant offering HISTAR® 460 that combines extremely demanding mechanical requirements with an excellent ease of processing at welding. The Differdange mill is known for an excellent track record of delivering tall buildings of this nature and is a proud supplier in helping to shape the skylines of cities across the world.

### • Steel Structure

The Lakhta Center was originally designed as structure consisting of massive steel columns, with composite floors, reinforced concrete outriggers, and a reinforced concrete core. To save time, reduce costs and improve the constructability. The structural design was optimised, taking advantage of the benefits of using steel and concrete together. In addition to optimising the layout of the beams in the composite floors, the columns were adjusted to be more efficient composite columns and the steel outriggers were encased to help connect the columns to the building's core.

### • ArcelorMittal technical support

At ArcelorMittal, the detection and following of this project already began in 2008. Over the years, at each phase of the project's development, the teams convinced the structural engineers and the general contractor of the job to select a solution with heavy sections. Our research center in Esch (Luxembourg) was right from the start on board to support the mill in fine-tuning the quality of the steel and to achieve its homologation as HISTAR® 460 Russia with the relevant official institute and authority in Russia.





America

Height: 182m (597ft)  
 Number of Floors: 46  
 Gross floor area: 79 524m<sup>2</sup>  
 Building Function: Office  
 Structural material: A steel diagrid frame supported by concrete-reinforced steel super columns, with a steel core and composite floors  
 Completion: 2006  
 Architect: Foster + Partners; Adamson Associates  
 Structural Engineer: WSP Cantor Seinuk  
 General Contractor: Turner Construction Company  
 ArcelorMittal Steel: 8 000 tonnes in A913 Grade 65  
 Fabricator: Cives Northern

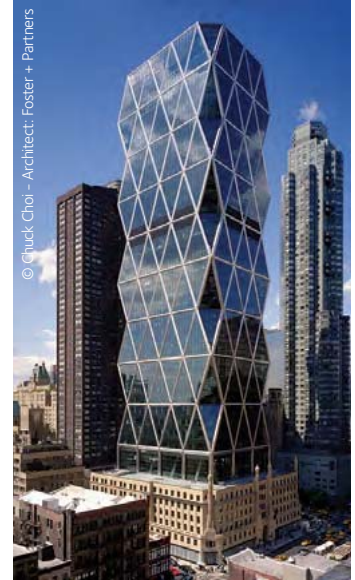

## Hearst Tower (New York, USA)

**Project Overview:** A six-storey, Art Deco building, commissioned by William Randolph Hearst to house his publishing empire, completed construction on New York City's 8th Avenue in 1928. Envisioned as the base of a skyscraper, the height was stunted due to the Great Depression. More than 70 years later, the Hearst Tower gave nod to Mr. Hearst's vision by incorporating his original building's façade into its final design. The tower presents a distinctive method to create dialogue between old architecture and new by using a completely glass facade that appears to be floating above the base. Upon entering the building, occupants are greeted with a spacious lobby, which occupies the entire space of the original building and provides access to the main elevator lobby, cafeteria, auditorium and meeting areas.

Building systems	Steel Solutions	ArcelorMittal Solutions			Fire resistance
		Heavies	High strength steel	Finished beams	
 Bracing		diagrid			sprayed
 Columns		perimeter column: W14 x 16	A913 - Grade 65		sprayed/Intumescent coating
Floor solutions			A913 - Grade 50	composite beams	sprayed

### • Structural System

The four sides of Hearst Tower are formed by a diagonal steel structure wrapping around the perimeter of the building and braced by a steel core. This series of 16,5-meter-tall triangulated structural elements form a steel "diagrid" – an efficient structural form that results in a 20-percent reduction in the volume of steel required to support the building, when compared to a conventional moment frame structure. Bolstered by ten-storey-tall concrete-reinforced steel super columns, the diagrid system contributes to the building's overall structural stability and in conjunction with the tower's composite steel and concrete floors, enables 12-meter-long column-free spans throughout the building's interior.

### • ArcelorMittal Steel Sections

Contributing more than 10 000 tonnes of structural steel to this project, ArcelorMittal's HSTAR Grade 460 (ASTM A913 Grade 65) sections make up the visually striking diagrid system, visible on the facade of the building, and serving as the wind bracing and gravity load system. The external cladding of the diagrid is covered with

stainless steel to give the tower its clean and modern finish.

### • Sustainability

Considered one of the most environmentally friendly buildings ever constructed, Hearst Tower was the first New York City commercial office building to achieve LEED Gold Certification from the US Green Building Council and bettered itself in 2012 with a LEED Platinum rating. Built using 85-percent recycled steel and designed to consume 26-percent less energy than conventional buildings, the building's sustainable features include: a 64-cubic-meter reclamation tank that collects rainwater runoff from its roof; a high-performance, low-emission glass facade that enables internal spaces to be flooded with natural light, while limiting solar radiation from overheating interior spaces; light sensors that control the amount of artificial light used on each floor based on the available natural light; motion sensors that allow lights and computers to be automatically turned off in vacant rooms; and high-efficiency heating and air-conditioning equipment, which utilise outside air for cooling and ventilation for 75 percent of the year.



America

Height: 236m (774,3ft)  
 Number of Floors: 57  
 Gross floor area: 199 781m<sup>2</sup>  
 Building Function: Office  
 Structural material: A steel diagrid and braced frame perimeter, with composite floors  
 Completion: 2012  
 Architect: Foster + Partners, Zeidler Partnership Architects  
 Structural Engineer: Halcrow Yolles  
 General Contractor: Ledcor Construction Limited  
 ArcelorMittal Steel: 4 900 tonnes of W14 x 16 sections  
 Fabricator: Supreme / Walters Joint Venture



## The Bow (Calgary, Canada)

**Project Overview:** Calgary's second tallest building, The Bow features a unique curved design that is articulated by its external structural steel diagrid. Derived from an in-depth climate analysis, the south-facing tower's bold form curves toward the sun to maximize occupants' exposure to natural light and heat, and by turning the convex facade into the prevailing wind, the structural loads are minimised. The building features three spacious, six-storey-tall sky gardens and a series of atria, which gives occupants a working environment that promotes sociability and interaction.

Building systems	Steel Solutions	ArcelorMittal Solutions			Fire resistance
		Heavies	High strength steel	Finished beams	
 Bracing		diagrid	A913 - Grade 65		sprayed + protective metal coating
 Columns		W14 x 16	A913 - Grade 65		sprayed
Floor solutions				composite beams	sprayed

### • Structural System

To achieve the building's aesthetic, sustainability, geometry, and space planning goals, steel was a natural choice for The Bow's structure. The building's distinct perimeter diagrid frame contributes to its hybrid lateral force resisting system (LFRS) – the remainder of which is composed of three braced frames on the curved south elevation, two on the north elevation, and steel moment resisting frames throughout.

Due to its location south of the Bow River, it was required that the top of the building be low enough to avoid casting shadows on the river in the September equinox. To achieve this demand, a network of interior columns was added to cut down floor spans and maintain a depth of floor framing less than 485mm.

### • ArcelorMittal Steel

As Canada's largest steel-framed building, The Bow is comprised of 39 000 tonnes of steel, of which 3 320 tonnes are ArcelorMittal's HSTAR Grade 460 (ASTM A913 Grade 65) wide-flange shapes. The use of high strength structural steel enabled benefits that include: smaller vertical load carrying members; lightweight, long-span floors; large column free areas for more open spaces and increased flexibility to meet tenant needs; as well as more economic foundations, when compared to a concrete building, due to reduced weight of the overall structural system.



America

Height: 541,3m (1776ft)  
 Number of Floors: 94  
 Gross floor area: 325 279m<sup>2</sup>  
 Building Function: Office  
 Structural material: Steel moment frame, with a reinforced high-strength concrete core  
 Completion: 2014  
 Architect: Skidmore, Owings & Merrill LLP  
 Structural Engineer: WSP Group; Schlaich Bergermann und Partner  
 General Contractor: Tishman Construction  
 ArcelorMittal Steel: 15 000 tonnes of steel, primarily W14 x 16 in A913 - Grade 65  
 Fabricator: Banker and ADF



## One World Trade Center (New York, USA)

**Project Overview:** Representing renewal and hope, One World Trade Center stands at a symbolic 1 776 feet (541m) in height – including its spire – and features a slender, tapering triangular form that shimmers in the light and acknowledges the National September 11 Memorial that exists adjacent to it. The tower’s design is an innovative mix of architecture, safety and sustainability sets a high standard of social responsibility in urban design by incorporating new architectural and environmental standards. With a total usable floor area of over 325 000m<sup>2</sup>, the tower is composed of 71 levels of office space, a grand public lobby, an observation deck, parking, 5 100m<sup>2</sup> of below-grade retail space, as well as broadcast and antennae facilities.

Building systems	Steel Solutions	ArcelorMittal Solutions			Fire resistance
		Heavies	High strength steel	Finished beams	
 Bracing		concrete core + steel frame	A913 - Grade 65		sprayed
 Columns		internal columns: W14 x 16	A913 - Grade 65		sprayed
Floor solutions				cellular beams	sprayed

### • Structural System

One World Trade Center’s structure employs a ductile perimeter steel moment frame that surrounds a reinforced concrete core wall system, which work together to provide resistance to gravity, wind and seismic forces. The combined structure lends substantial rigidity and redundancy to the overall building, while providing column-free interior spans for maximum office flexibility. The building’s chamfered corners form an aerodynamic and structurally efficient shape, which reduces exposure to wind loads and therefore reduces the amount of building materials necessary due to lower demands on the tower’s lateral system.

### • ArcelorMittal Steel Sections

While ArcelorMittal supplied both structural steel sections and plates for the tower’s steel frame, the project features more than 12 500 tonnes of structural shapes, including

HISTAR® Grade 460 (ASTM A913 Grade 65) sections as large as W14x730 serving as columns at the perimeter of the tower’s base.

### • Safety and Fire Design

Following a new generation of life-safety standards, which incorporate redundant measures, the structure features enhanced fireproofing for the structural steel, an egress route (core) that is enclosed by up to three feet of reinforced concrete, dual interconnected fire standpipes, and extra water storage to allow for high capacity sprinkler heads. In addition to its concrete-enclosed core, the tower includes a protected tenant-collection point on each floor and a separate stairwell for first responders. From an architectural perspective, these features were all integrated into the design without negatively affecting the efficiency or constructability, and they are considered highly advanced state-of-the-art life-safety systems that will lead the way for new high-rise building standards.



America

Height: 221m (724ft); Number of Floors: 54  
 Gross floor area: 136 010m<sup>2</sup> (1,463,999 ft<sup>2</sup>)  
 Building Function: Office; Completion: 2017  
 Structural material: Steel columns, composite beams and concrete core  
 Developer: Riverside Investment & Development  
 Architect: Goettsch Partners  
 Structural Engineer: Magnusson Klemencic Associates  
 General Contractor: Clark Construction Group, LLC  
 ArcelorMittal Steel: 3534 t incl. 1365 t of W14 x 16 in A913 Grade 65 and  
 109 t of W14x16 and W14 x 16 in A913 - Grade 70  
 Fabricator: Zalk Josephs



## 150 North Riverside (Chicago, USA)

**Project Overview:** Located just meters away from the Chicago River to its east and a century-old railway to its west, 150 North Riverside is a 54-storey office building that features 136 010m<sup>2</sup> of leasable space. A signature component of the building is the core-supported structure, which was required in response to the constraints of the site. This innovative solution resulted in the tower's dramatic form and enabled its footprint to have an area 70-percent smaller than the typical floors above.

Building systems	Steel Solutions	ArcelorMittal Solutions			Fire resistance
		Heavies	High strength steel	Finished beams	
 Bracing		concrete core with steel frame	A913 - Grade 65/70		sprayed
 Columns		internal columns	A913 - Grade 65		sprayed
Floor solutions				composite beams	sprayed

### • Structural System

Designed as a typical office building from level 8 through level 54, the core-supported plan employs an efficient, yet complex, transfer truss system to shift the load from its exterior columns to be supported on its concrete core. The core rests on a 3m-deep concrete mat supported on a collection of 16 rock-socketed caissons below, each with a 3m diameter.

### • ArcelorMittal Steel

Constructed using 2 530 tonnes of ASTM A913 Grades 65 and 70 wide-flange shapes, these products not only enabled the design of a more efficient structure, but they also contributed to simplification in the fabrication and erection of the complex elements in this system. Benefits include:

- Reduction of 18% (550 tonnes) in the weight of wide-flange column elements, a benefit that limits the building's carbon footprint, lowers material transportation costs and decreases the demand on crane lifts

- Substitution of single W36x925 (A913 Grade 65) rolled sections to replace the built-up, concrete-filled box sections originally considered for the sloping transfers to the concrete core
- Utilisation of toe-to-toe W36x925 (A913 Grade 65) rolled sections in lieu of built-up box sections at the mega-columns at the building's north and south faces
- Elimination of the need for preheat at A913 Grade 65 columns where heavy cantilevered floor framing elements connected across the section

### • ArcelorMittal Technical Support

Working closely with the structural engineer and fabricator, ArcelorMittal's technical support team consulted on value engineering propositions that enabled a 6% total savings in the weight of the structural frame and resulted in this tower being first in the world to employ the world's largest structural shapes: W36x925 and W14x873 sections.





America

Height: West Tower - 214,7m (704ft); East Tower - 196m (643ft)  
 Number of Floors: West Tower - 52; East Tower - 44  
 Gross floor area: West Tower - 128 113m<sup>2</sup>; East Tower - 112 477m<sup>2</sup>  
 Building Function: West Tower - Office; East Tower - Residential and Office  
 Structural material: Steel frames, with concrete cores and composite floors  
 Completion: West Tower - 2010; East Tower - 2016  
 Architect: KPMB Architects; Adamson Associates; WZMH Architects (West Tower Only); ERA Architects (West Tower Only)  
 Structural Engineer: West Tower - Halcrow Yolles; East Tower - Entuitive  
 General Contractor: EllisDon Construction Services Inc.  
 ArcelorMittal Steel: 1 915 tonnes A913 - Grade 65, 1 330 tonnes in A913 - Grade 70  
 Fabricator: Walters



## Bay-Adelaide Centre (Toronto, Canada)

**Project Overview:** Located in Toronto's financial district, and comprised of the presently completed East Tower (22 Adelaide Street West) and West Tower (333 Bay Street), as well as the planned North Tower, Bay-Adelaide Centre will – upon completion – house more than 300 000 sq m of “AAA” class commercial office space, a city park and an open-air plaza. Originally conceived in 1987, the development has a storied history, having passed through numerous proposed configurations, a selection of construction starts and stops, and most important in the storybook of structural steel – it has twice served as the pilot project for ArcelorMittal's HISTAR® (ASTM A913) steel.

Building systems	Steel Solutions	ArcelorMittal Solutions			Fire resistance
		Heavies	High strength steel	Finished beams	
 Bracing Columns		concrete core with steel frame	A913 - Grade 65/70		sprayed
		internal columns	A913 - Grade 65		sprayed
Floor solutions				composite beams	sprayed

### • ArcelorMittal Steel Sections

Bay-Adelaide Centre's East and West Towers are both composite buildings that feature structural steel gravity systems with a central concrete core that resists lateral loading. Combined, ArcelorMittal has contributed more than 5 285 tonnes of material to these buildings, including 1915 tonnes of ASTM A913 Grade 485 and 1330 tonnes of ASTM A913 Grade 70. For Bay-Adelaide Centre's East Tower, the structural system realised an overall weight savings of more than nine percent when the high-strength steel was used in columns and short-span transfer girders – a benefit that not only reduced the cost of the building, but also contributed to limits in the loss of useable floor area due to reduced sizes of vertical columns.

### • ArcelorMittal Technical Support

Bay-Adelaide Centre's lead structural engineer has stated that working on the design of an office complex for more than 25 years enabled ample opportunity for innovation. Embracing that notion, the engineer continuously engaged with ArcelorMittal's technical support team, to access literature on new products, understand material composition, and obtain material test results – intel that was necessary to evaluate value engineering options and to present new products for approval by building code officials. The successful collaboration between this engineer and ArcelorMittal's technical support team resulted in Bay-Adelaide Centre holding titles of being first development in the world to use HISTAR® Grade 460 (ASTM A913 Grade 65) – for design of the 1989 version of the project's first tower\* – and being first in the world to use HISTAR® Grade 485 (ASTM A913 Grade 70) – for the construction of the East Tower.

\* Bay-Adelaide Centre's first tower – namely, South Tower – was the first high-rise in the world to incorporate HISTAR® (ASTM A913) steel into its design. Material for the first several levels of the building was produced, delivered, and fabricated, but due to an economic recession in Toronto, the building ceased construction in 1991 and its HISTAR® (ASTM A913) steel was not erected.



Asia

Height: 354,6m (1 163ft)  
 Number of Floors: 54  
 Gross floor area: 68 500m<sup>2</sup>  
 Building Function: Office  
 Structural material: Steel columns, outriggers and belt trusses, with a concrete core  
 Completion: 2000  
 Architect: NORR Limited  
 Structural Engineer: Hyder Consulting; Leslie E. Robertson Associates  
 General Contractor: Brookfield Multiplex  
 ArcelorMittal Steel: 5 000 tonnes in HISTAR® 460  
 Fabricator: Eversandai



## Emirates Tower One (Dubai, UAE)

**Project Overview:** The Jumeirah Emirates Towers are one of the most distinctive skyscraper duos in the world and were some of the first high-rises to be located along Sheikh Zayed Road in the financial centre of Dubai. Their completion in 2000 began a trend that has since seen the thoroughfare boom with construction activity and some of the tallest towers in the world.

Building systems	Steel Solutions	ArcelorMittal Solutions			Fire resistance
		Heavies	High strength steel	Finished beams	
 Bracing	concrete core + outriggers + belt trusses		HISTAR® 460		sprayed
 Columns					sprayed
Floor solutions				composite beams	sprayed

### • Structural System

The towers rise from a three-storey terraced podium, which houses a boutique retail mall, restaurants and cafés. At the base, intersecting planes of curvilinear and vertical elements frame grand staircases that lead to the podium levels. Clad in silver aluminium panels with both silver and copper reflective glass, the slim towers capture shifting sunlight throughout the day and enhance the bright city lights at nightfall.

Both towers feature equilateral cross sections with a triangular footprint that affords the structure more stability from the lateral forces of wind and earthquakes. In Emirate Tower One, steel transfers at level nine distribute loads from concrete-filled steel tubular columns into three triangular legs at the perimeter. Three additional transfer floors and a tuned mass damper at the peak provides for maximum stability. A steel and concrete hybrid solution throughout the tower allows for an abundance of column-free office space.

### • HISTAR® 460

Building stability is provided by coupling the central reinforced concrete core to the perimeter columns using outrigger and belt trusses at plant room levels. The outrigger and belt trusses run around the perimeter of the building and connect back to the core and are made with ArcelorMittal's high-strength HISTAR® 460 steel sections.



Asia

Height: 207,8m (682ft)  
 Number of Floors: 57  
 Gross floor area: 179 600m<sup>2</sup>  
 Building Function: Residential; Office  
 Structural material: Steel  
 Completion: 2015  
 Architect: Broad Sustainable Building Co., Ltd  
 Structural Engineer: Sky City Investment Co., LTD  
 General Contractor: Sky City Investment Co., LTD  
 ArcelorMittal Steel: 10 345 tonnes of prefabricated sections in HISTAR® 460  
 Fabricator: Yuanda Keijian



## J57 Mini Sky City (Changsha, China)

**Project Overview:** J57 Mini Sky City was built in a combined construction time of only 19 days, which is almost at a pace of 3 completed floors per day. The tower was developed by Broad Sustainable Building (BSB), which is a construction company specialising in prefabricated buildings. The tower was built with energy-efficient, factory-produced elements, using the BSB prefabricated construction method, which won the 2013 Council on Tall Buildings and Urban Habitat (CTBUH) Innovation Award. Using this construction method reduced the use of up to 15 000 concrete trucks and avoided the release of dust associated with conventional Chinese construction processes. J57 includes 19 ten-meter tall atriums, 800 apartments and office space for 4 000 people, which highlights the flexibility of the building use, even if it uses this construction method.

Building systems	Steel Solutions	ArcelorMittal Solutions			Fire resistance
		Heavies	High strength steel	Finished beams	
 Bracing Columns		pre-fabricated steel frames	HISTAR® 460		sprayed
Floor solutions				modular construction	sprayed

- **Steel Structure**

90% of the tower is made of manufactured block that are developed offsite. The block can simply be locked together and secured with high strength ribs and bolts. This provides adequate structure, increases the rate of construction, and simplifies the construction process. The flexibility of the spaces, strength of the structure, rate of construction, and the accuracy and precision of each module can only be achieved by using steel elements.

- **HISTAR® 460 prefabricated sections**

ArcelorMittal provided 10 345 tonnes of HISTAR® steel sections from Differdange to build the frame of J57 Tower. The team of ArcelorMittal Europe – Long Products supplied was selected by BSB, due to the accuracy of the size and strength of their steel sections; this is the most crucial element to ensure that prefabricated buildings are built according to the construction schedule.

- **Sustainability**

According to the Architect of J57, Xian Min, in addition to significantly reducing the amount of concrete required and eliminating the dust on the construction site, this construction method is so energy efficient that it will save 12 000 metric tonnes of CO<sub>2</sub> emissions compared to conventional buildings with a similar function. Furthermore, another reason for which ArcelorMittal was specifically selected was the fact that the majority of the steel from Differdange was derived from recycled scrap steel elements.

- **Speed of construction**

The structure of J57 is entirely made of steel and has no concrete core. As it was 90% prefabricated in the factory it was possible to erect 3 floors per day. In total, less than 19 days were necessary to erect the building, hosting 4 000 offices and 800 apartments.



Asia

Height: 106m (348ft)  
 Number of Floors: 23  
 Gross floor area: 103 308m<sup>2</sup>  
 Building Function: Office  
 Structural material: Composite columns, with steel mega trusses  
 Completion: 2006  
 Architect: Skidmore, Owings & Merrill LLP  
 Structural Engineer: Skidmore, Owings & Merrill LLP  
 General Contractor: China State Construction Engineering Corporation  
 ArcelorMittal Steel: 4 500 tonnes in HISTAR® 420/355  
 Fabricator: Jinggong Gang-Gou



## Poly Corporation Headquarters (Beijing, China)

**Project Overview:** Poly Corporation Headquarters, located in Beijing, houses the various subsidiaries of the China Poly Group Corporation. The building consists of 24 unique, L-shaped office floors, which are built around a 90-meter tall atrium. The atrium is enclosed by the world's largest cable-net supported glass wall. Upon completion in 2006, this interior atrium became the tallest lobby in the world, completely free of any columns.

Building systems	Steel Solutions	ArcelorMittal Solutions			Fire resistance
		Heavies	High strength steel	Finished beams	
 Bracing Columns		columns + mega truss	HISTAR® 420/355		sprayed
Floor solutions				composite beams	sprayed

### • ArcelorMittal Steel Sections

The distinctive atrium of the Poly Corporation Headquarters is made possible by the unique façade support system, developed by Skidmore, Owings and Merrill LLP, known as the Rocker. The "Rocker" allows the cable-stayed system, which uses two large, parallel-strand bridge cables in diagonal fold lines, to accommodate any effects of earthquakes and heavy winds and assist in the suspension of the 8-storey museum structure within the atrium. This entire system is supported by the mega truss at the top of the tower.

Furthermore, the building was the first building designed and erected with ASTM A913 (HISTAR®) grades in China; before completion of this tower, the highest grade of steel specified

in building applications in China was 345MPa. ASTM A913/Gr. 450 (65ksi) was a too big jump from 345MPa steel for the committee of experts. They approved ASTM A913 up to 420MPa (60ksi) after welding tests without preheating at room temperature and mechanical tests on Jumbo sections were performed at the Welding Research Institute in Beijing (CRIBC) to convince the committee of experts of the excellent behaviour of HISTAR® steel. Thus, all the columns of the building as well as the mega truss on top, which supports the façade of glass, were designed in 420MPa.

### • Fire resistance

Composite columns were used in the structure, which provides acceptable fire resistance.





Asia

Height: 494,3m (1 622ft)  
 Number of Floors: 101  
 Gross floor area: 381 600m<sup>2</sup>  
 Building Function: Hotel; Office  
 Structural material: Steel outriggers and belt trusses, with composite megacolumns and a concrete core  
 Completion: 2008  
 Architect: Kohn Pedersen Fox Associates; Mori Building; Irie Miyake Architects and Engineers  
 Structural Engineer: Leslie E. Robertson Associates  
 General Contractor: China State Construction Engineering Corporation ; Shanghai Construction Group  
 ArcelorMittal Steel: 17 000 tonnes in HISTAR® 355  
 Fabricator: 'Grand Tower' Steel Structure



## Shanghai World Financial Center (Shanghai, China)

**Project Overview:** The Shanghai World Financial Center, located in Shanghai's Pudong District, is a symbol of commerce and culture that speaks to the city's emergence as a global capital. This landmark is comprised of 101 storeys and reaches almost 500 meters above the city skyline. Its appearance combines two intersecting arcs and a square prism – forms representing the ancient Chinese symbols for earth and sky. Upon completion in 2008, it became the tallest building in China and second tallest in Asia (second only to TAIPEI 101). It also received the CTBUH 2008 Best Tall Building Asia & Australasia and Best Tall Building Worldwide award.

Building systems	Steel Solutions	ArcelorMittal Solutions			Fire resistance
		Heavies	High strength steel	Finished beams	
 Bracing Columns	mega-composite columns	HISTAR® 355		sprayed	
	concrete core + outriggers + belt trusses			sprayed	
Floor solutions			composite beams	sprayed	

### • Steel Structure

High-strength steel was the obvious choice for the main structure of the building to reduce its weight. The entire structure consists of three parallel and interacting systems:

1. the mega-structure consisting of the major structural columns, the major diagonals, and the belt trusses to form a braced frame;
2. the concrete walls of the services core; and
3. the outrigger trusses which interact between the concrete walls and the megacolumns.

The diagonals of the mega-structure are formed from welded structural steel boxes. These steel boxes are filled with concrete, providing increased stiffness, non-linear structural behaviour, and structural damping. The columns of the mega-structure are of composite structural steel and reinforced concrete, one at each of the four corners of the rectilinear base and six as the floor plan morphs into a six-sided form at higher levels.

### • HISTAR® 355

ArcelorMittal supplied 17 000 tonnes of high-strength steel HISTAR® 355 sections, which were used in the outriggers trusses, belt trusses and megacolumns.

### • Robustness, Redundancy and Safety

The structural system is designed to accept the simultaneous loss of several structural elements. For example, at any level the small perimeter columns can be accidentally removed without the disproportionate collapse of the surrounding structure. Additionally, members of the perimeter belt trusses can be removed without disproportionate collapse. Similarly, accidental removal can be accepted for the steelwork within the services core.

Regarding fire safety, the exits, fire and smoke propagation were studied using a service approach (which guaranteed a level of safety in excess of legal requirements) with computer simulations that led to some modifications in design (i.e. width of stairs, location of exits) to improve building evacuation times. Being a mixed steel and concrete structure, it was possible to ensure optimal fire protection and impact resistance for the entire steel structure of Shanghai World Financial Center.

*“ArcelorMittal’s technical support is thoughtful, forward-looking and robust. MKA continues to benefit from the collaborative and supportive relationship ArcelorMittal provides.”*

**Ron Klemencic, P.E., S.E., Hon. AIA**

Chairman & CEO



Seattle, USA

## 14. ArcelorMittal services

### • Technical Advisory

ArcelorMittal provides you with technical advice to optimise the use of our products and solutions in your projects for free. The technical advice covers basic and elaborated concepts, counterproposals, predesigned of structural elements, construction details, assistance in value engineering, surface protection advisory, metallurgy, welding procedure and fire protection. Our specialists are ready to support your initiatives all over the world.

To facilitate the design of your projects, we also offer software and technical documentation that you can consult and download for free from our website:

**[sections.arcelormittal.com](https://sections.arcelormittal.com)**

Contact us at: **[sections.sales@arcelormittal.com](mailto:sections.sales@arcelormittal.com)**

### • Steligence® Fabrication Centre

As a complement to the technical capacities of its partners, ArcelorMittal is equipped with high-performance finishing tools and can provide a wide range of fabrication services, including the following:

- drilling of materials up to 140mm in thickness
- flame cutting
- T cut-outs
- notching
- cambering
- curving
- straightening
- cold sawing to exact length
- welding and fitting of studs
- shot blasting
- surface treatment

Contact us at: **[cs.eurostructures@arcelormittal.com](mailto:cs.eurostructures@arcelormittal.com)**

### • Sales Network

Our sales network works closely with all ArcelorMittal mills. We provide you with a seamless interface with mills offering world-class products and services throughout the globe. You can find the complete list of our agencies on the next two pages and on our website.

### • R&D

With 1 500 full-time researchers employed across the globe, our research centers are at the heart of developing new steel products and solutions. To keep us at the forefront of innovation in steelmaking and mining technology, ArcelorMittal has 11 research centers located in Europe and North America.

In 2018 we invested \$290 million in R&D, with ≈40% of that money targeted on processes, ≈55% on products and solutions and 5% on exploratory research.

### • ArcelorMittal in Construction

ArcelorMittal has also a website dedicated to a full range of products for the construction market (structures, façades, roofing, etc.): **[constructalia.arcelormittal.com](https://constructalia.arcelormittal.com)**

# ArcelorMittal International

## Headquarters

### LUXEMBOURG

ArcelorMittal International Luxembourg  
24-26, Boulevard d'Avranches  
LU-1660 Luxembourg  
T: +352 4792 4800

## Sales agencies

### AFRICA

ArcelorMittal International Africa  
Casaneashore park  
Shore 18- N° 302-2  
1100, Bd Al Qods - Sidi Maarouf  
MA- Casablanca  
T: +212 522 74 96 00

### BRAZIL

ArcelorMittal International Brasil  
Alameda Santos 700, 12° andar, Cerqueira Cesar  
CEP 01418-100 SP - São Paulo  
T: +55 11 36 38 69 04

### CHILE

ArcelorMittal International Chile  
Av. Providencia, 1208 - Oficina 1805  
Ed. Pamplona/Providencia/Santiago  
T: +56 2 2248 3391

### CHINA (People's Republic of)

ArcelorMittal International Shanghai  
Unit A2-13F Time Square, 500 Zhangyang Road  
Pudong, CN- Shanghai 200122  
T: +86-21 58 36 82 00

ArcelorMittal International Beijing  
Beijing Vantone Center, Tower A, Room 1702 No. 6  
Chaowai Street, Chaoyang District 100020 Beijing  
CN- 100020 Beijing  
T: +86-10 59 07 05 03

ArcelorMittal International Hong Kong  
Room 2301, 88 Hing Fat Street,  
Causeway Bay, Hong Kong  
T: +852 2522 4123

### COLOMBIA

ArcelorMittal International Colombia  
Calle 90 N° 12 # 45 Of. 605 - Bogotá  
T: +57 1 623 40 22

### ECUADOR

ArcelorMittal International Ecuador  
Calle del Establo y Av. De los Conquistadores  
Edif. Cemacol, Ofic. F - Cumbayá  
CP 170902 - Quito  
T: +593 2 289 2161 / 2162

### EGYPT

ArcelorMittal International Fze Representative Office  
Unit No F19, Floor No 1,  
Katameya Heights Business Center,  
5<sup>th</sup> Settlement, New Cairo 11835 - Egypt  
T: +20 2 20200084

### INDIA

ArcelorMittal International India  
Unit 202 A, Dosti Pinnacle,  
Wagle Industrial Estate,  
IN-400604 Thane (West)  
T: +91 22 4248 9518

ArcelorMittal International India  
6<sup>th</sup> Floor, M6, Uppal Plaza (Near Apollo Hospital)  
Jasola Community Center, Jasola  
IN- 110044 New-Delhi  
T: +91 11 46759492

### KOREA

ArcelorMittal International Korea  
6F Jinnex Lakeview, 99 Ogeum-Ro  
Songpa-Gu, Seoul, Korea  
Postal code 05548  
T: 82-2-6200-6571

### MEXICO

ArcelorMittal International Mexico  
Calle Privada de los Industriales 110 A  
Desp. 802  
Col. Industrial Benito Juarez  
Queretaro, Qro.  
MX-76100 MEXICO  
T: +52 442 218 6872

### NIGERIA

ArcelorMittal Projects Nigeria  
22B Olori Muyibatu Oyefusi Street  
Off Omorinre Johnson  
Lekki Phase 1, Lagos, Nigeria  
T: +234 1 277 0802

### PERU

ArcelorMittal International Peru  
Calle Tomas Ramsey N°930  
Oficina 1105 - Magdalena del Mar - Lima 17  
T: +51 1 26 13 131

### RUSSIA

ArcelorMittal International Moscow  
Bolshaya Ordynka Street 44, building 4  
RU-119 017 Moscow  
T: +7 495 721 15 51  
F: +7 495 721 15 55

### SENEGAL

ArcelorMittal International Africa  
Immeuble Lot 43  
Ambassade du Luxembourg  
Cité des jeunes cadres Lébous  
Route de l'Aéroport Léopold  
Sédar Senghor - Yoff BP 11750 Dakar, Senegal  
M +221 775 696 354/ +221 785 897 232

### SINGAPORE

ArcelorMittal International Singapore  
08-01/05 Anson House - 72, Anson Road  
SG-079911 Singapore  
T: +65 67339033

### SOUTH AFRICA

ArcelorMittal South Africa  
PO Box 2 PP 10109  
Vanderbiljpark 1900  
REPUBLIC OF SOUTH AFRICA  
T: +27 (0)16 889 4440  
T: +27 (0) 889 3661

### TAIWAN

ArcelorMittal International Taiwan  
8F A3; n° 502 Jiou Ru 1st Rd.  
San Min Dist., Kaohsiung - TAIWAN ROC  
T: +886 7 390 04 25

### TURKEY

ArcelorMittal CL Çelik Deş Ticaret A.Ş.  
Esentepe Mah. Büyükdere Cad.  
Metrocity A Blok 171/A Kat:23 Şişli  
TR-34394 Istanbul  
T: +90 212 317 49 24

### UNITED ARAB EMIRATES

ArcelorMittal International FZE  
Plot S40703 - South Zone 4  
AE-PO Box 262098 - Dubai  
T: +971 4 803 5900

### UNITED STATES OF AMERICA

ArcelorMittal International North America  
1 South Dearborn, 18<sup>th</sup> floor  
US-Chicago, IL, 60603  
T: +1 312 899 3500

### UKRAINE

ArcelorMittal International Ukraine  
20 Velyka Zhytomyrska str.  
01025 Kyiv, Ukraine 01601  
T: +38 044 321 0 321

### VIETNAM

ArcelorMittal International Vietnam  
D35, 40 Ba Huyen Thanh Quan, Ward 6  
Dist. 3, Ho Chi Minh City, VN  
T: + 84 28 39307248

# ArcelorMittal Commercial Sections

## Headquarters

### LUXEMBOURG

ArcelorMittal Commercial Sections  
66, rue de Luxembourg  
LU-4221 Esch sur Alzette  
T : +352 5313 3010

### SPAIN

ArcelorMittal Comercial Perfiles España S.L.  
Ctr. Toledo. Km. 9,200  
ES-28021 Madrid  
T : +34 91 797 23 00

## Sales agencies

### AUSTRIA

ArcelorMittal Commercial Sections Austria GmbH  
Vogelweiderstraße 66  
AT-5020 Salzburg  
T : +43 662 88 67 44

### BELGIUM + THE NETHERLANDS

ArcelorMittal Commercial Netherlands B.V.  
Eemhavenweg 70  
NL-3089 KH Rotterdam  
T : +31 (0)10 487 09 22

### BOSNIA HERZEGOWINA

ArcelorMittal Zenica  
Bulevar kralja Tvrtka, no. 17  
BA-72000 Zenica  
T : +384 32 467 268

### BULGARIA

ArcelorMittal Commercial Long Bulgaria  
26 Antim I str, office 6  
BG-1303 Sofia  
T : +359 287 09 028

### CZECH REPUBLIC

ArcelorMittal Europe CZ s.r.o.  
Francouzská 6167  
CZ-708 00 Ostrava Poruba  
T : +420 553 401 005

### DENMARK

ArcelorMittal Commercial Long Denmark A/S  
Artillerivej 90, stuen  
DK-2300 Copenhagen S  
T : +45 33 74 17 11

### ESTONIA

ArcelorMittal Commercial Baltics OÜ  
Roosikrantsi 2  
EE-10119 Tallinn, Estonia  
T : +372 51979170

### FINLAND

ArcelorMittal Commercial Long Finland OY  
Topeliuksenkatu 15  
FI-00250 Helsinki  
T : +358 9 74 222 460

### FRANCE

ArcelorMittal Commercial Long France S.A.S.  
Domaine de Pelus  
16, Avenue de Pythagore  
FR-33700 Merignac  
T : +33 5 57 92 09 10

### GERMANY

ArcelorMittal Commercial Long Deutschland GmbH  
Gereonstraße 58  
50670 Köln  
T : +49 221 572 90

Augustenstraße 7  
DE-70178 Stuttgart  
T : +49 711 489 80 0

### GREECE AND CYPRUS

ArcelorMittal Europe - Long Products  
9, Karagiorga Saki Str  
GR-16675 Glyfada Athens  
T : +30 210 960 42 79

### ITALY

ArcelorMittal Commercial Italy  
Strada Torino 43  
IT -10043 Orbassano (Torino)  
T : +39 011 906 3931

### NORWAY AND ICELAND

ArcelorMittal Commercial Long Norway A/S  
Holmenveien 20,  
NO-0374 Oslo  
T : +47 22 83 78 20

### POLAND

ArcelorMittal Commercial Long Poland  
Al. Pilsudskiego 92  
PL-41 308 Dabrowa Gornicza  
T : +48 32 776 92 45

### ROMANIA

ArcelorMittal Commercial Long Romania S.R.L.  
7 9 Intrarea Tudor Stefan  
2<sup>nd</sup> Floor, AP. 4  
Sector 1, 011 655 Bucharest  
T : +40 31 405 47 93

### SWEDEN

ArcelorMittal Commercial Sweden AB  
Västmannagatan 6  
S-11124 Stockholm  
T : +46 8 534 80 94 0

### SWITZERLAND

ArcelorMittal Commercial Schweiz AG  
Industriestrasse 19  
CH-8112 Otelfingen  
T : +41 56 437 16 70

### TURKEY

ArcelorMittal CL Çelik Deş Ticaret A.Ş.  
Esentepe Mah. Büyükdere Cad.  
Metrocity A Blok 171 /A Kat:16 - Şişli  
TR-34394 Istanbul  
T : +90 212 317 4980

### UNITED KINGDOM

ArcelorMittal Commercial UK Ltd  
3rd Floor, Fore 2  
Huskisson Way, Shirley  
Solihull B90 4SS - Great Britain  
T : +44 121 713 6600

## Services

### Stelience® Fabrication Centre

Z.I. Gadderscheier  
L-4984 Sanem  
Tel.: +352 5313 3057  
cs.eurostructures@arcelormittal.com

Find also your local agency at  
[sections.arcelormittal.com/About.us](https://sections.arcelormittal.com/About.us).

